



Hydrogeological Assessment Proposed Gas Station 16621 Hwy 12, Midland, ON

Ref. No: DES21-03-13A
March 18, 2022



Prepared for: 2825951 Ontario Ltd.

Prepared by: Frontop Engineering Limited



TABLE OF CONTENTS

1.0 INTRODUCTION	4
2.0 METHODOLOGY	4
3.0 PHYSICAL SETTING	5
3.1 Physiography	5
3.2 Geology	6
3.3 Groundwater	6
4.0 ENVIRONMENTAL SETTING	7
4.1 East Branch of Georgian Bay	7
4.2 Little Lake	7
4.3 Mud Lake	7
4.4 Wye River Downstream of Mud Lake	7
4.5 Source Water Protection Plan.....	8
4.5.1 Wellhead Protection Area (Q2).....	8
4.6 Natural Heritage	8
5.0 SITE SUBSURFACE CONDITION	8
5.1 Stratigraphy	8
5.2 Groundwater Flow and Level.....	9
5.3 Hydraulic Conductivity	9
5.3 Infiltration Rate	10
5.4 Groundwater Quality	11
6.0 PROPOSED DEVELOPMENT.....	11
7.0 CONSTRUCTION DEWATERING ASSESSMENT.....	11
7.1 Dewatering Rate Estimation.....	11
7.2 Discharge Location.....	14
7.3 Method of Dewatering.....	14
8.0 IMPACT ASSESSMENT	14
8.1 Impact to East Branch of Georgian Bay	15
8.2 Impact to Little Lake	15
8.3 Impact to Mud Lake	15
8.4 Impact to Wye River Downstream of Mud Lake	15
8.5 Impact to Natural Heritage Features.....	15



8.6 Impact to Other Groundwater Users.....	16
8.7 Impact to Foundation Soil of Building, Pavement and Underground Facilities.....	16
8.8 Impact to Surface Drainage	16
8.9 Impact to Municipal Water Supply System.....	16
9.0 PTTW, EASR AND MUNICIPAL PERMITS	17
10.0 RECOMMENDATIONS ON WATER TAKING PLAN, DISCHARGE PLANA AND MONITORING PLAN	17
10.1 Water Taking Plan.....	17
10.2 Discharge Plan.....	18
10.3 Monitoring Plan.....	18
11. CLOSURE	19
REFERENCES	20
Figure 1 – Site Investigation Plan	21
Figure 2 – Wells within 500 m Radius	22
Figure 3 – Well Logs	23
Figure 4 – Cross Sections	24
Figure 5 – Groundwater Table Contours and Flow Direction	25
Appendix A: Well Records	26
Appendix B: Slug Test Results	27
Appendix C: Grain Size Analysis and K-value.....	28
Appendix D: Water Quality Test Results	29
Appendix E: Gas Tank Specification.....	30



1.0 INTRODUCTION

Frontop Engineering Limited (Frontop) was retained by 2825951 Ontario Ltd. (the Client) to carry out a hydrogeological assessment for the proposed development, located at 16621 Hwy 12, Midland, Simcoe County, ON (the Site). It should be noted that this hydrogeological assessment was conducted in tandem with the geotechnical investigation.

The purpose of this hydrogeological assessment was to obtain required hydrogeological information at the Site with a limited number of boreholes and monitoring wells, in-situ hydraulic tests, water chemistry test and laboratory program, and based on the assessment of the hydrogeological information to provide hydrogeological comments and recommendations for construction dewatering and related issues.

2.0 METHODOLOGY

The methodology employed to do the hydrogeological assessment included record review, borehole drilling and monitoring well installation, groundwater monitoring, hydraulic tests, and groundwater sampling.

Detailed record review was conducted for the area surrounding the Site to delineate the regional setting of the Site, including physical setting and environmental setting. The regional setting will help delineate site condition, help with data interpretation, and help with impact assessment. The sources of records reviewed are listed in the REFERENCES.

Boreholes were drilled as part of the geotechnical investigation, and three monitoring wells were installed following guidelines of Regulation 903. Well logs were attached as Figure 3. Data acquired through borehole drilling was the major sources of information for delineating site subsurface conditions. Groundwater monitoring and groundwater sampling were conducted from these monitoring wells.

Slug test was conducted on May 19, 2021 in two of the three monitoring wells (BH1 and BH2) to estimate hydraulic conductivity (K-value). The slug test was executed in accordance with ASTM D4044 (Standard Test Method for Field Procedure for Instantaneous Change in Head (Slug) Tests for Determining Hydraulic Properties of Aquifers) and generally accepted practices in Ontario. Basically the execution of the slug test for this project followed the following steps:

- Preparation of wells before the slug test, including well rinsing, well development and groundwater level monitoring;
- Set up logger level recording frequency at one record per second in office;
- Get to site and confirm well conditions;
- Sink logger steadily but swiftly into well bottom while at the same time injecting tap water to create 0.3 to 1.0 m water head;
- Wait and measure water level once per hour until water level recover to initial level;
- Retrieve logger;
- Data processing.



Based on site conditions, the falling head, water slug method was adopted. The result of the slug test were attached as Appendix B.

Grain size analysis was conducted for two representative samples (BH2-1 and BH2-6) to estimate hydraulic conductivity (K-value) for the stratigraphy units that could not be tested by the slug tests. The test results are attached as Appendix C.

Groundwater was sampled following the generally accepted procedures. The samples were tested against storm sewer standard of the Town of Midland. The test results are attached as Appendix D.

3.0 PHYSICAL SETTING

Physical setting is referred to as regional conditions in physiography, geology and groundwater surrounding the Site, which will help delineate the site conditions and interpret data and information collected about the Site, as well as help with dewatering assessment and impact analysis.

The physical setting was delineated through record review. Record review covered all public available sources of information and data, including provincial agencies, federal agencies, conservation authorities and local municipalities. Data sources reviewed are listed under REFERENCES.

3.1 Physiography

The Site is located at the south border area of the Town of Midland, and is out of the jurisdiction of Conservation Ontario. The area surrounding the Site was mapped by Ontario Geological Survey (OGS) as Sand Plain with pavement boulders and shorecliff in physiography.

The Site is located in Wye River watershed, close to the divide area between Wye River watershed to the south and the South Georgian Bay Shoreline watershed to the north. Wye River system links to Nottawasaga River system, however, Wye River watershed is not within the jurisdiction of Nottawasaga Valley Conservation Authority (NVCA).

The Site is in a semi-continental climate region with a warm, humid summer and a cold winter as well as wet spring, dry summer and moderate rainfall in autumn. The following table lists the average and daily values of major climate parameters collected from the closest climate station (Midland Water Pollution Control Plant) for the available period from 1981 to 2020. This climate station is located about 3 km to the north of the Site.

Average Value	Jan	Feb	Mar	Apr	May	Jun	Jul	Aug	Sep	Oct	Nov	Dec
Daily Air T (°C)	-8.5	-6.4	-1.9	5.8	12.2	18.1	20.8	19.9	15.9	9.3	3.2	-3.1
Rainfall (mm)	21.5	20.9	36.1	59.3	92.8	89.5	72.7	77.9	99.1	88	74.8	27.5
Snowfall (cm)	88.3	49.3	29.6	5.9	0	0	0	0	0	2.1	28.9	76.9
Precipitation (mm)	109.8	69.9	65.7	65.1	92.8	89.5	72.7	77.9	99.1	90.1	103.6	104.4
Extreme Daily Value	Jan	Feb	Mar	Apr	May	Jun	Jul	Aug	Sep	Oct	Nov	Dec
Extreme Daily Rainfall (mm)	37.8	27.4	39	41.4	73	79.8	89	61	80	95.5	37.2	34
Extreme Daily Snowfall (cm)	35.8	42	34	35.6	9.7	0	0	0	0	17	45.7	50



Rainfall intensity-duration-frequency curve (IDF curve) reflects statistic interrelation between rainfall intensity, precipitation duration and frequency. The Engineering Development Design Standards of Town of Midland presented the IDF equations adopted by the town. Based on these IDF equations, the 100 years daily (24 hours) rainfall reaches 104.2 mm, and 2 years daily rainfall reaches 47.3 mm. The former is used as the worst, or extreme scenario and the latter is used as the normal operation scenario for dewatering rate calculation for the project.

3.2 Geology

Surficial overburden was mapped by Ontario Geological Survey (OGS) as ice-contact stratified deposits, including sand and gravel, minor silt, clay and till. Ice-contact stratified deposits usually have large thickness and make the major aquifer in Ontario.

Bedrock underlays the overburden and was mapped as Simcoe Group. The Simcoe Group was deposited during Middle Ordovician to Early Late Ordovician (O₂–O₃¹) age, and consists of five Formations of limestone, dolostone, shale, arkose and sandstone.

3.3 Groundwater

Groundwater flow and its levels are controlled by ground surface topography, hydrostratigraphy and climate conditions, and groundwater quality hinges on lithology of formation, evolution history and more on man-made contaminant.

As mentioned above, the Site is located on the northwest part of Wye River watershed, and close to the border of the South Georgian Bay Shoreline watershed. Groundwater is anticipated to flow from northwest to southeast towards Wye River or from southeast to northwest towards Little Lake. The climate pattern determines that groundwater levels usually have a trend of spring-high and summer-low.

Water Well Information System (WWIS) of Ontario is the most import source of regional groundwater information. Wells within 500 m radius of the Site was clipped out from the WWIS well Shapfile. Overall 22 wells were identified, and their locations are shown in Figure 2. The information of groundwater from each well was further queried from the WWIS master database with Well IDs. The detailed groundwater information from these 22 wells were attached as Appendix A, the following table is a summary of the well records.

Well Type	Record Number	Water Quality	Record Number
Domestic	10	Fresh	
Livestock	2		
Commercial	1	Salty	
Industrial		Untested	
Municipal		Unknown	
Monitoring		Aquifer	Record Number
Monitoring and Test Hole	2	Overburden	14



Dewatering		Bedrock	2
Unknown	5	Unknown	6
Not Used	2		

Among the 22 wells, ten domestic wells were identified, and all of them were installed between 1951 and 1978. Considering that the communities surrounding the Site had been serviced with municipal water supply and sewer system, most of the domestic well should not be in use for drinking water supply.

Most wells have depth ranging from 20 to 40 m, and groundwater levels become deeper with well depth, indicating a downward vertical gradient.

Closest PGMN (Provincial Groundwater Monitoring Network) Wells of MECP are located about 4.0 km to the west (W0000311-1). Groundwater levels from this PGMN well shows a yearly fluctuation of 0.5 m. Monitoring data from this PGMN well provides little information about groundwater at the Site.

4.0 ENVIRONMENTAL SETTING

Environmental setting is characterized of major environmental features of various scales surrounding the Site, which will help with the interpretation of site environmental conditions and with impact analysis. The environmental setting was delineated through reviewing existing environmental information, mostly from public sources (REFERENCES). Major environmental features close to the Site include Georgian Bay, Little Lake, Mud Lake, Wye River, source protection features, and natural heritages.

4.1 East Branch of Georgian Bay

Georgian Bay is divided by the Midland peninsular into west and east branches. The Site is about 12 km away from the west branch, and about 1.6 km from the east branch. The Site is separated from the east branch of Georgian Bay with mostly natural area and a bit residential area.

4.2 Little Lake

The Site is located about 1.2 km to the east of the Little Lake shoreline. Between the Site and the Little Lake, there are residential and commercial areas and open area. The Little Lake is upstream of the Site.

4.3 Mud Lake

Mud Lake is located about 1.2 km to the south of the Site. Mud Lake is an in-line lake of Wye River, and is downstream of the Site. The Site is separated from the Mud Lake with commercial area and natural area.

4.4 Wye River Downstream of Mud Lake

The Wye River downstream of Mud Lake is located about 1.2 km southeast of the Site. This part of Wye River is centralized in one main channel, and regulated with a dam. Commercial and natural areas separate the Site and the river.



4.5 Source Water Protection Plan

The Site is located in Severn Sound Source Protection Area, which is part of South Georgian Bay Lake Simcoe Source Protection Region.

Based on Ontario Source Protection Atlas and the Schedule G of the Official Plan of Midland, the Site is not located in quality Well Head Protection Area (WHPA), not located in Significant Groundwater Recharge Area (SGRA), not in Intake Protection Zone (IPZ), and not above Highly Vulnerable Aquifer (HVA).

It should be noted that both Ontario Source Protection Atlas and the Schedule G of the Official Plan of Midland show that the area bordering the northeast part of the property is designated as Significant Groundwater Recharge Area with a score of two (2).

4.5.1 Wellhead Protection Area (Q2)

Based on Ontario Source Protection Atlas and the Schedule G of the Official Plan of Midland, the Site is located in a quantity Well Head Protection Area (WHPA-Q2) with moderate stress level.

4.6 Natural Heritage

Based on the Schedule 5.2.2 of Simcoe County Official Plan and the Schedule C of the Official Plan of Midland, the wetland formed in connection with Mud Lake and Wye River (Wye Marsh) and the wetland formed along shoreline area of Little Lake are both designated as Provincially Significant Wetlands (PSWs). Wye Marsh is also designated as regionally Areas of Natural and Scientific Interest (ANSI) in the Schedule of Simcoe County Official Plan.

The Site is about 1.2 km away from the Wye Marsh and Little Lake shoreline wetland.

5.0 SITE SUBSURFACE CONDITION

Subsurface condition of the Site was delineated based on the information and data acquired through borehole drilling, groundwater monitoring, hydraulic test, groundwater sampling and grain size analysis.

5.1 Stratigraphy

Site stratigraphy not only serve as medium to support proposed structures but also act as porous medium to store and transmit groundwater. Based on the available information, the site stratigraphy is listed from top down in the following table. Figure 4 Cross Sections show the site stratigraphy.

Unit No	Unit Name	Lithology	Bottom Depth (mbgs)
1	Clayey Silt	Trace sand, soft to firm, moist to wet, brown to dark brown, some rootlets, no stain and no odor.	0.7
2	Gravelly Sand	Fine to medium sand matrix, some silt; 20 to 30 % sound to weathered, angular to subangular Precambrian rock clasts and some limestone clasts (3 to 8 cm); matrix supported, locally stratified,	4.0-8.4



		compact to very dense, wet to saturated, gray to brownish gray, no stain and no odor. Facies change to silty fine sand and medium sand horizontally	
3	Silty Fine Sand	Trace gravel, laminated, very dense, brownish gray, wet, no stain and no odor.	9.6

The predominant stratigraphic unit within the exploration depth is the second unit, Gravelly Sand. The Gravelly Sand unit changes facies to silty fine sand and medium sand horizontally and vertically. The facies change was marked by different amount of gravels or clasts, without significant change in matrix properties. In other words, the facies change is more of sedimentological structure, rather than mechanical and hydraulic properties of the stratigraphic unit.

Based on the results of moisture tracking (Figure 3), saturated zone is not continuous both horizontally and vertically.

5.2 Groundwater Flow and Level

Three monitoring wells (BH1 to BH3) were installed at the Site as part of the drilling program for the project. Groundwater conditions in the open boreholes were observed during and upon completion of drilling. Moisture condition of soil was tracked in order to predict and delineate groundwater condition, which were presented in Figure 3. The following table summarizes groundwater conditions in the three wells.

Monitoring Well ID	Screen Interval (mbgs)	GW Level (mbgs/masl)		
		First-Sight	Upon Completion of Drilling	May 19, 2021
BH1	5-6.5	Dry	1.83/212.22	4.63/209.42
BH2	9.6-11.1	2.43/211.51		9.27/204.67 (5.85/208.09)
BH3	3.5-5	Dry	3.05/211.05	3.29/210.81

It should be noted that the stabilized groundwater level in BH2 was measured in greater depth. The groundwater table depth used to create groundwater contours at BH2 was selected as the averaged value of the stabilized level and the first sight level. Based on the elevation of groundwater levels, the groundwater table contours and flow direction were delineated and shown in Figure 5. Based on the groundwater table contours, the horizontal groundwater gradient is about 20% and the flow direction is from east to west, to Little Lake. The large gradient may result from low hydraulic conductivity.

The great difference between the stabilized groundwater level in deeper BH2 and the stabilized groundwater levels in shallow wells (BH2 and BH3) indicates that the downward vertical gradient is significant at the Site, which is in conformance with the finding that the Site is located in a divide area of two watersheds and is a groundwater recharge area.

5.3 Hydraulic Conductivity

Predominant stratigraphic units under the Site is the second unit, Gravelly Sand. The K-value of the Gravelly Sand was estimated with slug tests and grain size analysis, and the K-value of the fill sand unit



was estimated with grain size analysis. The following table lists a summary of the test results. Detailed test records were attached as Appendix B and C.

Unit Name	Test	Sample/Well ID	K-value (m/s)	Averaged
Clayey Silt	Grain Size Analysis	BH2-1	1.1×10^{-8}	1.1×10^{-8}
Gravelly Sand	Slug Test	BH1	1.0×10^{-5}	6.2×10^{-6}
	Grain Size Analysis	BH2-6	2.3×10^{-6}	
Silty Fine Sand	Slug Test	BH2	7.6×10^{-6}	7.6×10^{-6}

5.3 Infiltration Rate

Infiltration rate is used to describe the perviousness of soil in vadose zone, which has a unit of cm/min or min/cm (T-time). It is an important parameter to assess soil condition for groundwater recharge, irrigation and septic system design. Several methods exist for estimating infiltration rate, including hydraulic conductivity (K-value), pit or hole percolation testing and Guelph Permeameter testing. For this project the first method was used to estimate the infiltration rate.

Estimation of infiltration rate with K-value was based on SG-6 Percolation Time and Soil Descriptions of the Supplementary Guidelines of Ontario Building Code 1997, and the following empirical correlation chart that was presented in the Stormwater Management Criteria of TRCA.

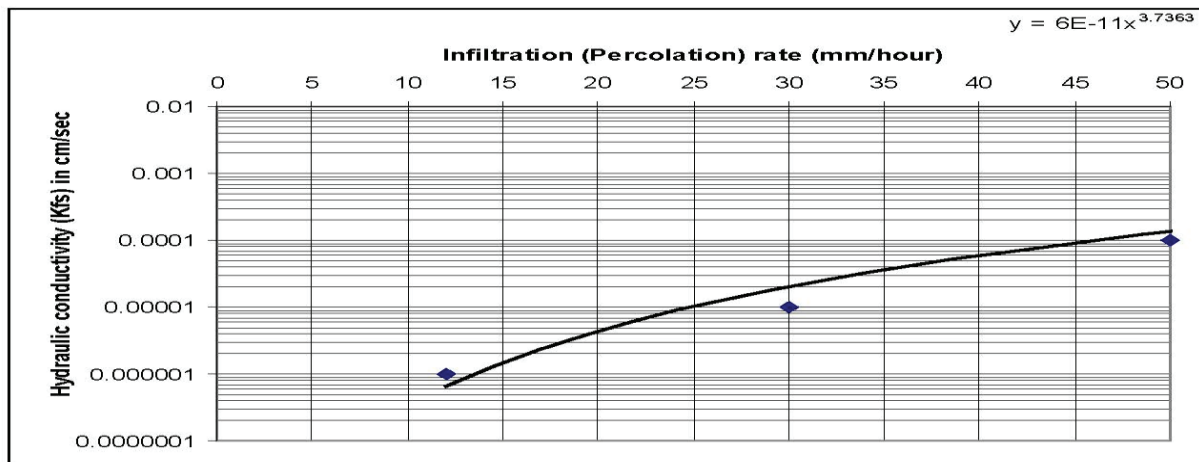

Source: Ontario Ministry of Municipal Affairs and Housing (OMMAH). 1997. Supplementary Guidelines to the Ontario Building Code 1997. SG-6 Percolation Time and Soil Descriptions. Toronto, Ontario.

The following table lists the results of infiltration rate estimation.

Unit Name	Test	Sample/Well ID	K-value (m/s)	Infiltration Rate	
				cm/min	T-time (min/cm)
Clayey Silt	Grain Size Analysis	BH2-1	1.1×10^{-8}	2.3	43
Gravelly Sand	Slug Test	BH1	1.0×10^{-5}	14.3	7
	Grain Size Analysis	BH2-6	2.3×10^{-6}	9.6	10
Silty Fine Sand	Slug Test	BH2	7.6×10^{-6}	13.3	8



5.4 Groundwater Quality

During drilling and sampling, groundwater was observed for any evidence of contamination such as objectionable odor, taste, visible film or sheen. No evidence of contamination was identified.

Water sampling was conducted on May 19, 2021, and sent to ALS Environmental Laboratory for testing against storm sewer parameters of Sewer Use Bylaw of Town of Midland (Bylaw 94-25). Test results were attached as Appendix D. The test results were compared with storm sewer discharge standard values and Table 3: Full Depth Generic Site Condition Standards in a Non-Potable Ground Water Condition of Regulation 153 of Ontario. No exceedance was identified.

6.0 PROPOSED DEVELOPMENT

Based on the terms of reference and the site plan drawing provided by the Client, the proposed development includes the following features:

- Two underground gas storage tanks with diameter from 2.4 to 3.0 m and length from 12.0 to 15.3 m. The excavation may extend to 3.6 to 4.2 m in width, 14 to 15 m in length and 4.0 to 4.5 m in depth;
- A four post gas canopy with footprint of 200 m²;
- A one story convenience store with a footprint of 218 m²;
- A one story restaurant building with a footprint of 194 m²; and
- Associated asphalt pavement.

It should be noted that the bottom of the completed gas tanks might be located in below groundwater level. Long-term impact of the gas tanks to groundwater quality will be addressed through gas tank structure engineering design and construction. The specification gas tanks to be used is attached (APPENDIX E) to show how potential issue of groundwater contamination is addressed.

It should be noted that dewatering is required only during sitting pit excavation and tank anchoring, which may last from 2 to 4 days.

7.0 CONSTRUCTION DEWATERING ASSESSMENT

As mentioned above, the excavation for gas tanks may extend to 4.5 mbgs. Considering seasonal fluctuation, groundwater levels may elevate to the levels above excavation base if construction is conducted during wet season. Therefore, construction dewatering should be considered.

7.1 Dewatering Rate Estimation

Dewatering for construction is conducted to fulfil three purposes: provide a dry working condition, help maintain ground stability and help maintain healthy and safe working environment. Dewatering rate (liters/day) is key parameter for implementing construction dewatering and impact assessment, and covers three parts of water that have potential to flow or seep into an excavation pit, including static groundwater



seepage, storage of groundwater that has to be depleted before groundwater flow attains a static state, and storm water.

Static Groundwater Seepage and Influence Zone:

The static groundwater seepage is estimated with the following Dupuit-Thiem equation (or well equivalent method):

$$Q = K(H^2 - h_w^2) / [0.733 \log (R / r_w)]$$

Q = pumping rate

K = hydraulic conductivity (m/s)

H = original water level (m) above lower aquitard

h_w = targeted level (m) above the lower aquitard

R = influence radius (combined) (m)

r_w = well radius or equivalent radius (m)

Radius of influence zone is calculated with Sichart and Kryieleis formula:

$$R_0 = C(H-h_w)K^{1/2}$$

C = 3000 for well.

$$R = R_0 + r_w$$

The excavation for the gas tank will go through mostly the second unit, Gravelly Sand. The maximal K-value of the unit penetrated by the excavation would be used to estimate the dewatering rate, which is the generally accepted practice and in line with provincial guidelines.

Information about the lower aquiclude at the Site is not available. Considering the generally low K-values at the Site and proximity to the Little Lake, the water edge elevation (200.00 masl) of the Little Lake is used here as the aquiclude (lower none flow boundary) elevation for calculating the pumping rate. The following tables list input values used and the calculation results. The influence zone was marked on Figure 2.

Input			Results		
Parameter	Unit	Value	Parameter	Unit	Value
K	m/s	7.6×10^{-6}	Pumping Rate	L/day	59710
H	m	9.42	Influence Radius	m	24
h_w	m	7.45	Influence Area	16 m from excavation footprint	
Excavation Area	m^2	180			

Storage of Groundwater:

The storage of groundwater was estimated based on porosity of excavated soil and the volume of excavated saturated soil plus the volume of saturated soil enclosed by drawdown cone and influence zone column. Assuming the construction period for the composite structure lasts for 4 days, the calculated storage to be



depleted before groundwater flow reaches static state is 333000 liters, corresponding to a daily pumping rate is 83232 L/day. The following tables list input values used and the calculation results.

Input	Unit	Value
Excavation Area	m ²	180
Influence zone Area	m ²	1788
Saturated Thickness	m	1.97
Saturated Soil Volume	m ³	1660
Porosity	%	20
Result		
Water Quantity	m ³	333
Daily Pumping Rate	L/day	83232

Stormwater:

The storm water was estimated based on 100 year daily rainfall (for worst or extreme operation scenario) and 2 year daily rainfall (for normal operation scenario) as discussed above. The catchment area was determined based on the crest of 1:1 cutting slopes. The following table lists input values used and the calculation results.

Input	Unit	Value
Catchment Area	m ²	457
100 Year Daily Rainfall	mm/day	104.2
2 Year Daily Rainfall	mm/day	47.3
Result		
Quantity-Normal Operation	L/day	21635
Quantity-Extreme Operation	L/day	47661

The following table lists the overall, combined dewatering rate.

Component	Unit	Value
Static Groundwater	L/day	59710
Storage	L/day	83232
Stormwater	Normal Operation	L/day 21635
	Extreme Operation	L/day 47661
Total Pumping Rate	Unit	Value
Normal Operation	L/day	164578
Extreme Operation	L/day	190604

It should be noted that values of input parameters for estimation of dewatering rate and construction procedures were selected erring on safe side.

As mentioned above, the saturated zone is not continuous both horizontally and vertically. Above dewatering rate is estimated based on the assumption that all formation under groundwater levels are saturated. As a result, the estimation is conservative. Actual groundwater seepage during excavation might be lower than the estimated rate.



7.2 Discharge Location

Based on MECP construction dewatering guides, there are several options for discharging pumped water, including:

- Discharge to a sewage works that has the appropriate environmental compliance approval (ECA);
- Transfer to a waste management system that has the appropriate environmental compliance approval (ECA) or is registered under the non-hazardous waste transportation systems EASR;
- Discharge to a municipal sanitary sewer or storm sewer in accordance with any municipal requirements;
- Discharge to surface land.

As reminded by the town review staff, discharge into sanitary system of the town is not permitted and there is no storm system surrounding the Site to receive the pumped water. Based on the feedback from the town and the proponent, it might be possible to discharge pumped water on the surface land within the property. The following is the steps recommended by Fronttop to ensure that the pumped water is discharged in accordance with the provincial guide and other public policies:

- A temporary pool should be created to hold pumped water. The depth of the pool should penetrate the first clayey silt layer (Figure 3) and sit on the gravelly sand unit to facilitate infiltration. The volume of the pool should be big enough to hold daily pumped volume under normal operation, which is 160 m³. Half day pumped volume is added to take into account the possible recycling of infiltrated water;
- The proponent should ensure the quality of pumped water is not changed. No contaminant and foreign materials should be allowed to enter the excavation pit, the pumped water and the temporary pool;
- Backup storage container such as tanks and totes should be in place just in case the capacity of the temporary pool is exceeded;
- The construction must be executed in dry weather. Otherwise the temporary pool should be enlarged to be resized based on the extreme operation condition, which is 178 m³;
- The proponent should put in place all necessary measures to prevent overflow from the temporary pool and backup containers into neighboring properties prior to get permissions from these property owners.

7.3 Method of Dewatering

Based on above estimated dewatering rates and site underground conditions, sump pump should be adequate for controlling groundwater seepage and stormwater that may accumulate in the excavation pit during construction.

8.0 IMPACT ASSESSMENT

Impact assessment is based on the understanding of the physical and environmental settings of the Site, the knowledge of the site subsurface condition, results of dewatering analysis, as well as proposed construction



and dewatering methodology. The following presents the assessment of impact to each major resource and environmental features and ways of mitigation if the impact is negative.

8.1 Impact to East Branch of Georgian Bay

The Site is about 1.6 km from the east branch. The Site is separated from the east branch of Georgian Bay with mostly natural area and a bit residential area. Based on the size of influence zone and discharge location, the dewatering will not have impact to the water quality and aquatic habitats of the East Branch of Georgian Bay.

8.2 Impact to Little Lake

The Site is located about 1.2 km to the east of the Little Lake shoreline. Between the Site and the Little Lake, there are residential and commercial areas, and open area. The Little Lake is upstream of the Site.

Considering the size of influence zone and discharge location, the dewatering will not have impact to the water quality and aquatic habitats of the Little Lake.

8.3 Impact to Mud Lake

Mud Lake is located about 1.2 km to the south of the Site. Mud Lake is an in-line lake of Wye River, and is downstream of the Site. The Site is separated from the Mud with commercial area and natural area.

Considering the size of influence zone and discharge location, the dewatering will not have impact to the water quality and aquatic habitats of the Little Lake.

Nonetheless, erosion and runoff related to construction have chances to migrate into Mud Lake if they are not managed appropriately. The issues of erosion and runoff generated on the Site would be addressed with formulating and implementing a site erosion and runoff control plan.

8.4 Impact to Wye River Downstream of Mud Lake

The Wye River downstream of Mud Lake is located about 1.2 km southeast of the Site. This part of Wye River is centralized in one main channel, and regulated with a dam. Commercial and natural areas separate the Site and the river.

Considering the size of influence zone and discharge location, the dewatering will not have impact to the water quality and aquatic habitats of the Wye River Downstream of Mud Lake.

Nonetheless, erosion and runoff related to construction have chances to migrate into Wye River Downstream of Mud Lake if they are not managed appropriately. The issues of erosion and runoff generated on the Site would be addressed with formulating and implementing a site erosion and runoff control plan.

8.5 Impact to Natural Heritage Features

Based on the Schedule 5.2.2 of Simcoe County Official Plan and the Schedule C of the Official Plan of Midland, the wetland formed in connection with Mud Lake and Wye River (Wye Marsh) and the wetland



formed along shoreline area of Little Lake are both designated as Provincially Significant Wetlands (PSWs). Wye Marsh is also designated as regionally Areas of Natural and Scientific Interest (ANSI) in the Schedule of Simcoe County Official Plan.

The Site is about 1.2 km away from the Wye Marsh and Little Lake shoreline wetland. Considering the size of influence zone and discharge location, the dewatering will not have impact to these Natural Heritage Features.

Nonetheless, erosion and runoff related to construction have chances to migrate into the Natural Heritage Features if they are not managed appropriately. The issues of erosion and runoff generated on the Site would be addressed with formulating and implementing a site erosion and runoff control plan.

8.6 Impact to Other Groundwater Users

As presented above and shown with Figure 2, twenty-two (22) wells were identified within 500 m radius of the Site, most of them are domestic wells. Considering no wells are within and close to the influence zone, as show in Figure, the impact to water quantity and water quality of supply wells is not anticipated.

8.7 Impact to Foundation Soil of Building, Pavement and Underground Facilities

As Figure 2 shows, there is no building and underground facilities within the influence zone of dewatering. However, Brandon Street is in contact with the boundary of the influence zone of dewatering. Considering the coarse grain size of the dewatered aquifer, the impact of dewatering to the pavement of Brandon Street is not anticipated.

8.8 Impact to Surface Drainage

As mentioned above, the pumped water is recommended to be discharged to surface land to infiltrate into ground through a temporary pool within the property. No surface runoff will be generated. Therefore, discharge of pumped water onto surface land within the property will not have any impact to the surface drainage.

8.9 Impact to Municipal Water Supply System

The water supply of Town of Midland is based on groundwater. As shown in Schedule G of the Official Plan and Ontario Source Protection Atlas, two well fields are located about 1.3 km to northeast and southwest of the Site, and the Site is not located in quality Well Head Protection Area (WHPA), not located in Significant Groundwater Recharge Area (SGRA), not in Intake Protection Zone (IPZ), and not above Highly Vulnerable Aquifer (HVA). However, the Site is located a quantity Well Head Protection Area (WHPA-Q2) with moderate stress level. The proposed development will increase the area of impervious and decrease groundwater recharge.

To mitigate the impact to the groundwater recharge, a water balance analysis has been completed to quantify the reduced groundwater recharge. Low Impact Development (LID) features would be considered.



9.0 PTTW, EASR AND MUNICIPAL PERMITS

Water taking in Ontario is governed with Section 34 of Ontario Water Resources Act and its Regulation 387/04. The act and regulation require that no person shall take more than 50,000 litres of water on any day by any means except in accordance with a permit. Three categories of Permit To Take Water (PTTW) were set out to cover water takings of deferent levels of impact to natural resources and environment.

Construction dewatering is governed with Part II. 2 of Environmental Protection Act and its Regulation 63/16. Based on the act and regulation, construction dewatering with rates between 50000 and 400000 L/day can go through Environmental Activity and Sector Registry (EASR) and do not have to apply for a PTTW if the impact to natural resource and environment is not significant and no sensitive features are involved.

Based on the above assessment and understanding of the water taking legislations, construction dewatering for this project satisfies all of the criteria for applying for EASR. Therefore, application for PTTW is not needed, and the Client has to go through EASR prior to starting dewatering. It should be noted that the EASR should be removed from the system upon completion of the dewatering through requesting with MECP.

10.0 RECOMMENDATIONS ON WATER TAKING PLAN, DISCHARGE PLANA AND MONITORING PLAN

The following presents general considerations for water taking plan, discharge plan and monitoring plan. These plans are meant to direct contractors in implementing dewatering operations and satisfy the needs for permit application with other agencies.

10.1 Water Taking Plan

Area of influence: 16.0 m out of proposed building footprint (Figure 2).

Extreme or worst operation watering taking rate: 190604L/day.

Impacts to foundation soil – soil settlement:

Soil settlement is not anticipated owing to the coarse grain size of formation.

Impacts – Other Water Users:

No water wells were identified in the MECP well records database within the influence area (Figure 2). It is noted that the area surrounding the Site are served with municipal water system. The impact to other water users is not anticipated.

Potential Impacts – Stream Water:

Potential impact to stream water is not anticipated because pumped water will be discharged within the property, and the Site is about 1200 m away from the creek.



Erosion and siltation may be issues. To control the erosion, facilities such as straw bales or straw rolls should be in place to block any silt and runoff from migrating out of the Site.

10.2 Discharge Plan

Extreme or worst operation discharge rate: 190604L/day.

Location and method of discharge: Temporary pool within the property. Discharge through a conveying pipe directly into the temporary pool.

Erosion and Sedimentation Control Measures:

As noted above in the mitigation measure section of the water taking plan, fencing, straw bales, strew rolls, erosion control blankets, or similar mitigation measures should be employed as appropriate to block erosion, and sedimentation from migrating away from construction site. All locations surrounding the Site should be inspected on a weekly basis to confirm that erosion and sedimentation control measures are functioning effectively.

10.3 Monitoring Plan

Monitoring plan for the purposes of PTTW, EASR, and other permission purposes belongs to the category of impact monitoring, and should cover such components as pumping rate monitoring, discharge monitoring, receptor monitoring and settlement monitoring.

Pumping Rate Monitoring:

For the duration of dewatering, daily average pumping rates and daily total discharge volumes will be recorded. The volume of water taken each day will be measured by a flow meter, or calculated based on the pump size and the rate and duration of pumping.

Discharge Monitoring:

The discharge will be observed on a daily basis for any signs of visible hydrocarbon film and sheen. In the event a film and sheen are observed, charcoal canister filters or another suitable means of hydrocarbon removal will be implemented immediately.

Receptor Monitoring:

The temporary pool should be monitored on a daily basis for the stability of slope walls, the variation of its infiltration rate and capacity, and the pumped water quality.

Settlement Monitoring:

Settlement monitoring is not needed since soil settlement is not anticipated as discussed above.

Record of Complaints:

During the dewatering, complaints related to dewatering discharge received will be recorded, along with any measures taken to address the complaints.



Monitoring Data Storage and Submission:

Monitoring data will be summarized and submitted to the MECP, other agencies or affected parties at the end of each calendar year, by March 31 of the following year, or other times as required by the affected parties. All monitoring data will be retained for five years.

Gas tank integrity monitoring:

As shown in APPENDIX E, the gas tanks to be used by the Client are of double wall fiber-glass structure, which are rust-proof and can be monitored constantly for structure integrity and leaking.

The Client will ensure that the transportation, handling and installation of gas tanks are executed as specified by the manufacturer, and the gas station will be operated following guidelines of MECP.

11. CLOSURE

We trust this report is satisfactory for your purposes. Should you have any questions or comments, please do not hesitate to contact our office.

Yours truly,

Frontop Engineering Limited



Frank Feng P. Eng
President



REFERENCES

Engineering Development Design Standards, 2012, Town of Midland.

Stormwater Management Requirements for Land Development Proposals, MTO Approvals
<http://www.mto.gov.on.ca/english/publications/drainage/stormwater/section4.shtml>

Official Plan, 2019, Town of Midland.

Chapman, L.J. and Putnam, D.F.
The Physiography of Southern Ontario, 1984, Ontario Geological Survey.

Canadian Climate Normals 1981-2010 Station Data, Environmental and Climate Change Canada
https://climate.weather.gc.ca/climate_normals/results_1981_2010_e.html?stnID=5097&autofwd=1

Interim Watershed Characterization Report TRCA Watersheds, 2007, Toronto and Region Conservation Authority

Ontario Digital Terrain Model Ministry of Natural Resources and Forestry.
<https://geohub.lio.gov.on.ca/>

Intensity-Duration-Frequency (IDF) curves, Ontario Ministry of Transportation (MTO).
http://www.mto.gov.on.ca/IDF_Curves/terms.shtml

MNDM. Ontario Geology Survey, Central Database
<https://www.mndm.gov.on.ca/en/mines-and-minerals/applications/ogsearth>

MECP. MAP Well Records of Ontario
<https://www.ontario.ca/environment-and-energy/map-well-records>

Water Well Information System (WWIS) of Ontario, Dataset
<https://data.ontario.ca/dataset/well-records>

MECP. Ontario Source Protection Atlas.
<https://www.gisapplication.lrc.gov.on.ca/SourceWaterProtection/Index.html?site=SourceWaterProtection&viewer=SWPViewer&locale=en-US>

MECP. Provincial Groundwater Monitoring Network
<https://www.ontario.ca/environment-and-energy/map-provincial-groundwater-monitoring-network>

Ontario Regulation 63/16, MECP

Surficial Geology, OGSEarth, Ministry of Energy, Northern Development and Mines, August 2019
<https://www.mndm.gov.on.ca/en/mines-and-minerals/applications/ogsearth>

Bedrock Geology, OGSEarth, Ministry of Energy, Northern Development and Mines, August 2019
<https://www.mndm.gov.on.ca/en/mines-and-minerals/applications/ogsearth>



Figure 1 – Site Investigation Plan

Legend

- Borehole
- Monitoring Well
- - - Section Line
- Site Boundary
- BH1: Borehole ID/
Monitoring Well ID

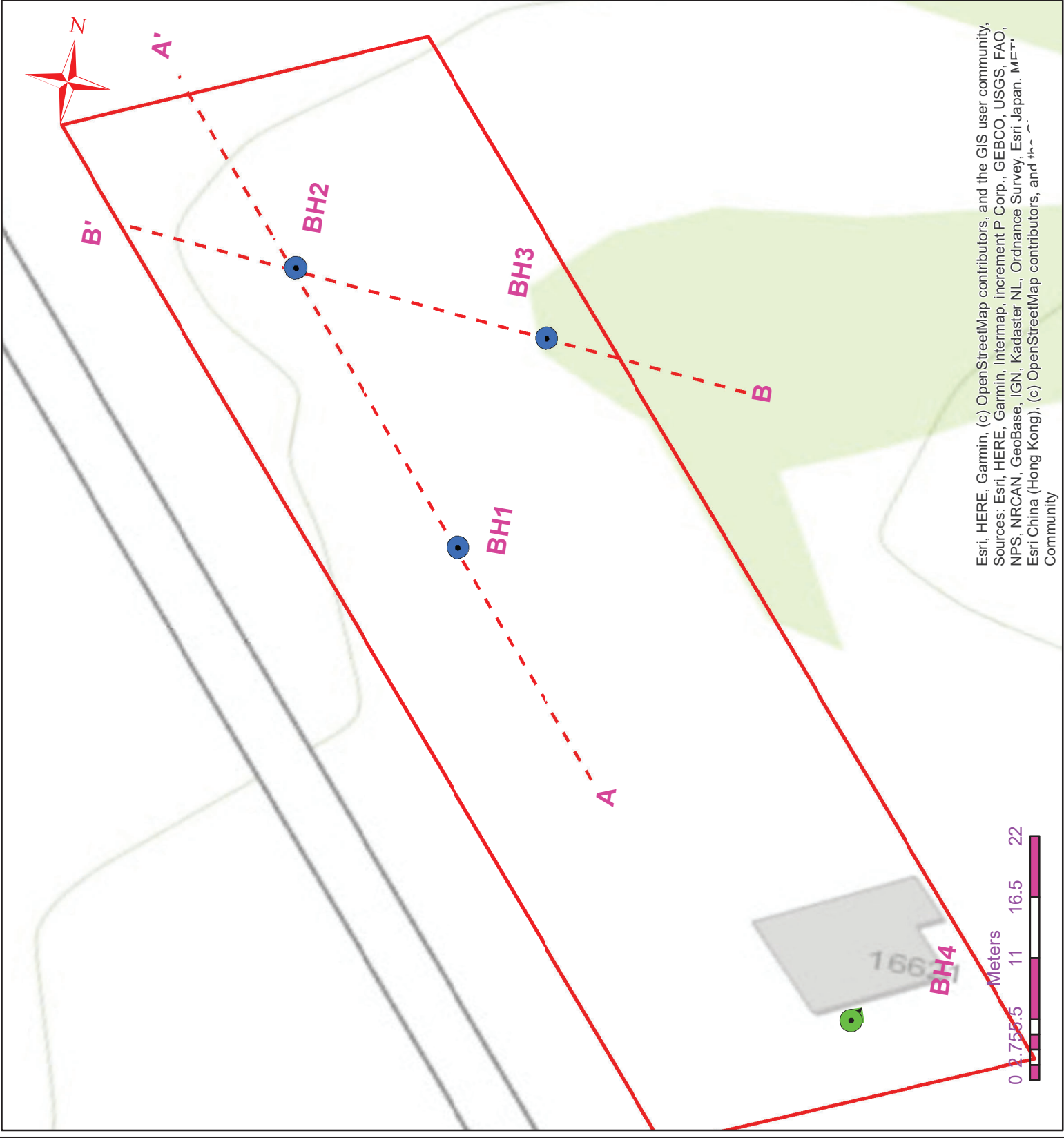

Esri, HERE, Garmin, (c) OpenStreetMap contributors, and the GIS user community, Sources: Esri, HERE, Garmin, Intermap, increment P Corp., GEBCO, USGS, FAO, NPS, NRCAN, GeoBase, IGN, Kadaster NL, Ordnance Survey, Esri Japan, METI, Esri China (Hong Kong), (c) OpenStreetMap contributors, and the GIS user community



Figure 2 – Wells within 500 m Radius



Legend

- 500 m
- Boundary for Well Search
- Well Record Location
- Excavation Footprint
- Influence Zone



Figure 2 Well Record and Influence Zone of Dewatering
DES21-03-13A
May 2021

Hydrogeological Assessment
16621 Hwy 12, Midland, ON

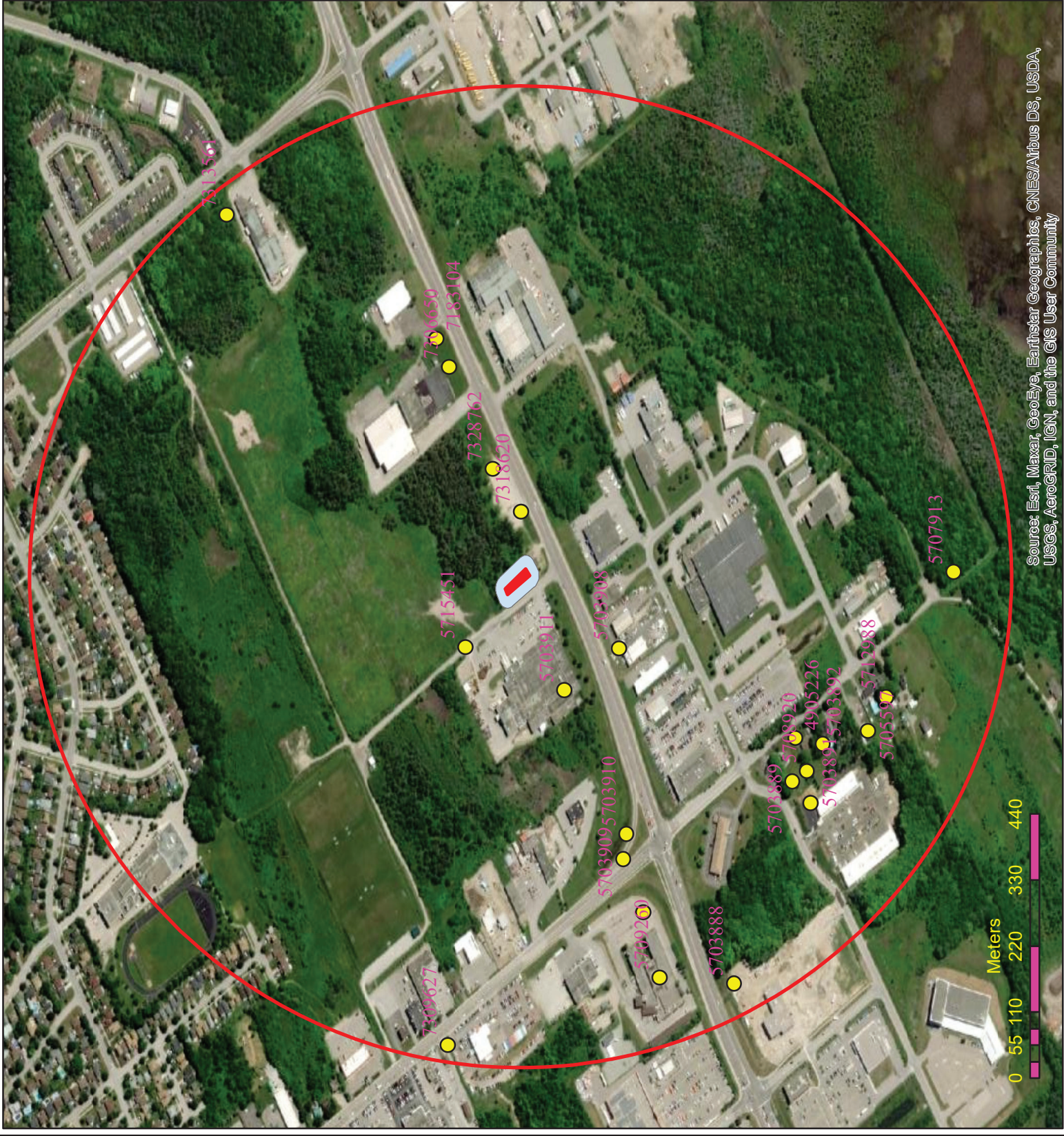

Source: Esri, Maxar, GeoEye, Earthstar Geographics, CNES/Airbus DS, USDA, USGS, AeroGRID, IGN, and the GIS User Community



Figure 3 – Well Logs

Log of Borehole 1

Project No. DES21-03-13A

Drawing No. 2

Project: Geotechnical Investigation

Sheet No. 1 of 1

Location: 16621 Hwy 12, Midland, ON

Date Drilled: May 5, 2021

Auger Sample

Combustible Vapour Reading

SPT (N) Value

Natural Moisture

Dynamic Cone Test

Plastic and Liquid Limit

Shelby Tube

Undrained Triaxial at

Field Vane Test

% Strain at Failure

Penetrometer

Drill Type: GEO205

Datum: Geodetic

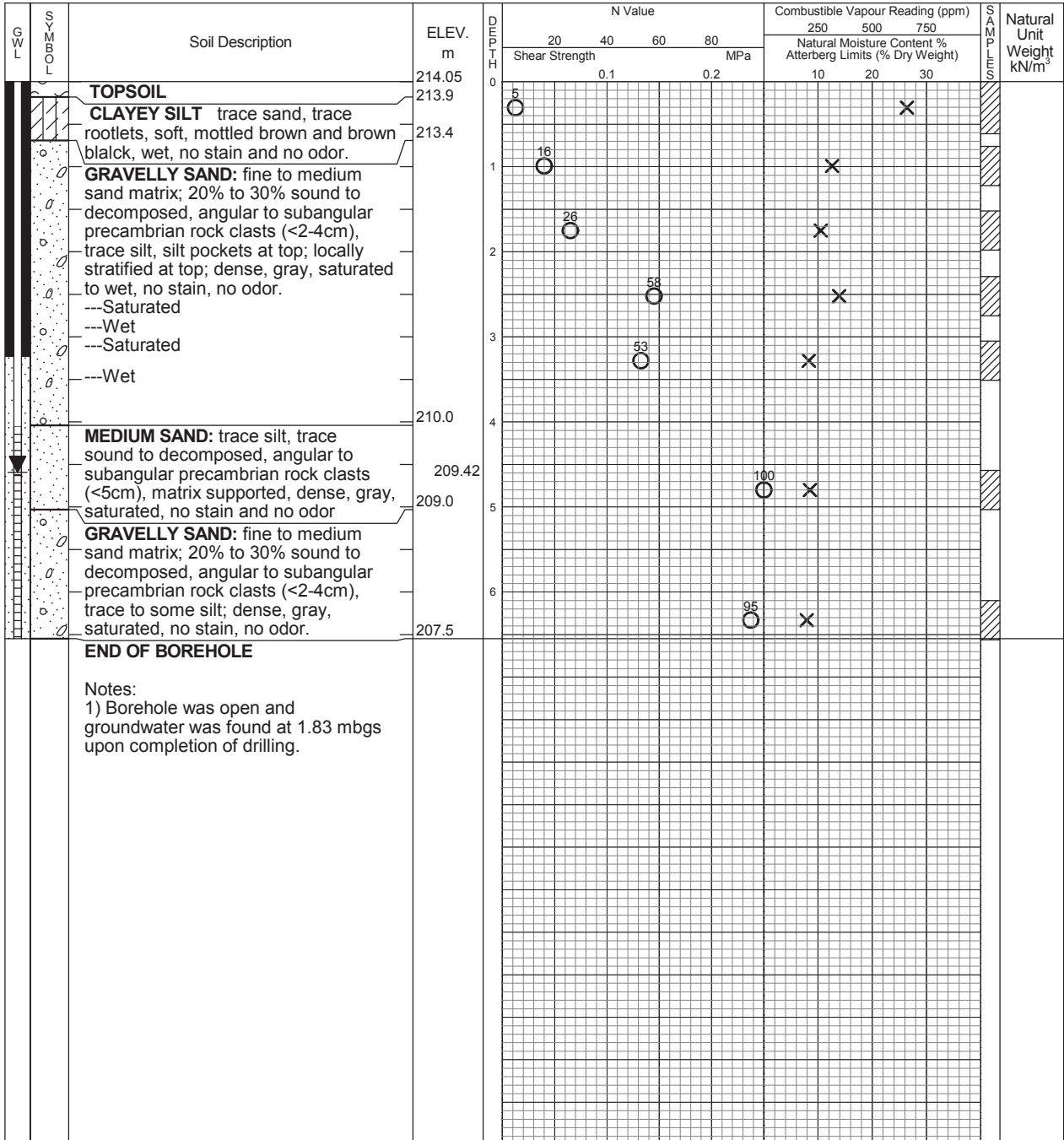

FRONTOP ENGINEERING LTD.

Time	Water Level (m)	Depth to Cave (m)
On completion May 19, 21	1.83 4.63	

Log of Borehole 3

Project No. DES21-03-13A

Drawing No. 4

Project: Geotechnical Investigation

Sheet No. 1 of 1

Location: 16621 Hwy 12, Midland, ON

Date Drilled: May 12, 2021

Auger Sample

Combustible Vapour Reading

Drill Type: D-9

SPT (N) Value

Natural Moisture

Datum: Geodetic

Dynamic Cone Test

Plastic and Liquid Limit

Shelby Tube

Undrained Triaxial at % Strain at Failure

Field Vane Test

Penetrometer

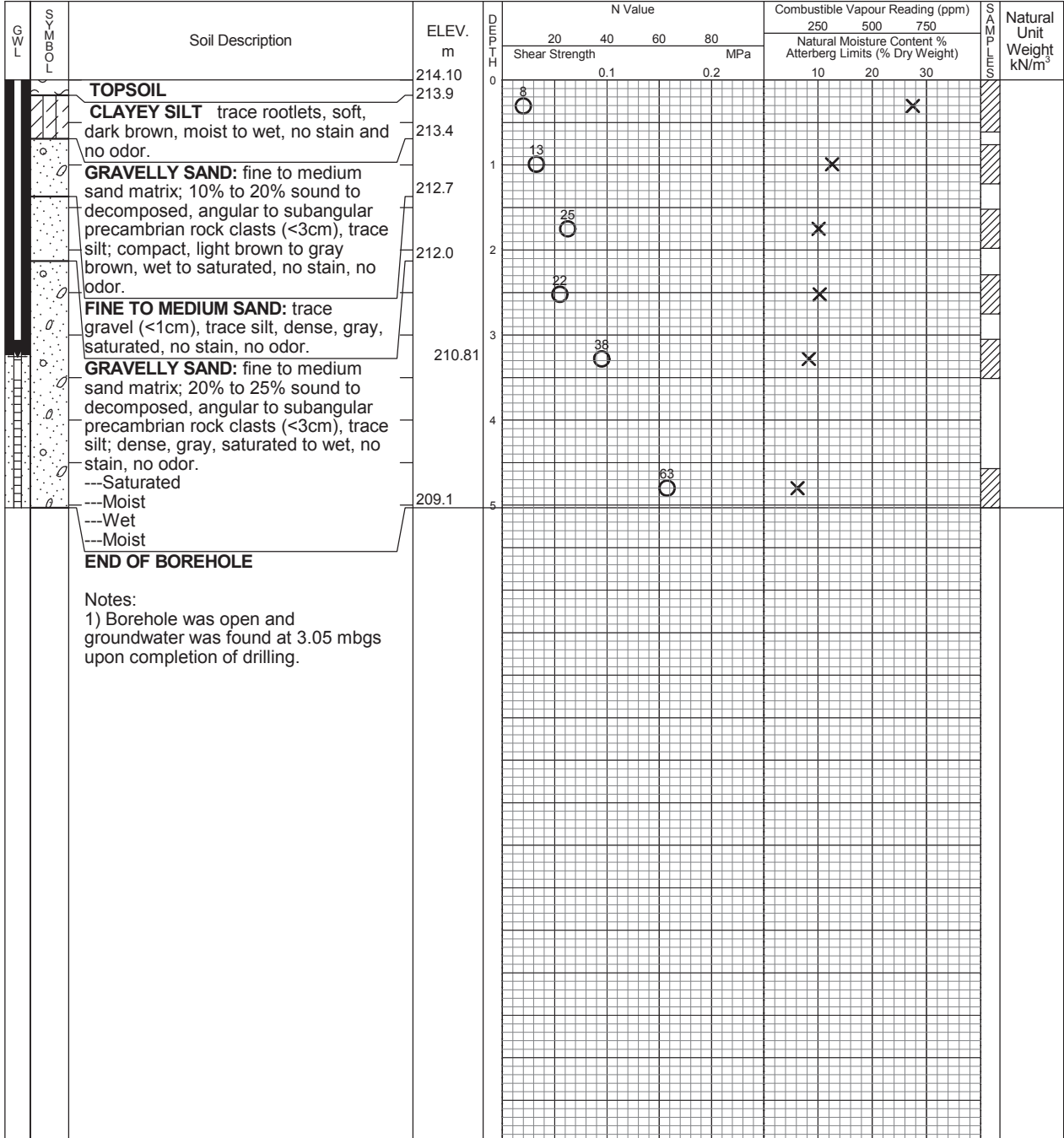

FRONTOP ENGINEERING LTD.

Time	Water Level (m)	Depth to Cave (m)
On completion May 19, 21	3.05 3.29	

Log of Borehole 4

Project No. DES21-03-13A

Drawing No. 5

Project: Geotechnical Investigation

Sheet No. 1 of 1

Location: 16621 Hwy 12, Midland, ON

Date Drilled: May 12, 2021

Auger Sample

Combustible Vapour Reading

Drill Type: D-9

SPT (N) Value

Natural Moisture

Datum: Geodetic

Dynamic Cone Test

Plastic and Liquid Limit

Shelby Tube

Undrained Triaxial at % Strain at Failure

Field Vane Test

Penetrometer

GWL	SYMBOL	Soil Description	ELEV. m	DEPTH	N Value				Combustible Vapour Reading (ppm)			SPT	Natural Unit Weight kN/m ³	
					20	40	60	80	250	500	750			
		TOPSOIL	213.98	0										
		CLAYEY SILT trace sand, firm, dark brown to brown black, moist to wet, no odor and slightly stain.	213.9											
		GRAVELLY SAND: fine to medium sand matrix; 20% to 30% sound to decomposed, angular to subangular precambrian rock clasts (<3-8cm); soft to dense, light brown, saturated to wet, no stain, no odor.	213.3											
		Upper part might have been disturbed.												
		END OF BOREHOLE	210.5	3										
		Notes: 1) Borehole was open and dry upon completion of drilling.												



FRONTOP ENGINEERING LTD.

Time	Water Level (m)	Depth to Cave (m)



Figure 4 – Cross Sections

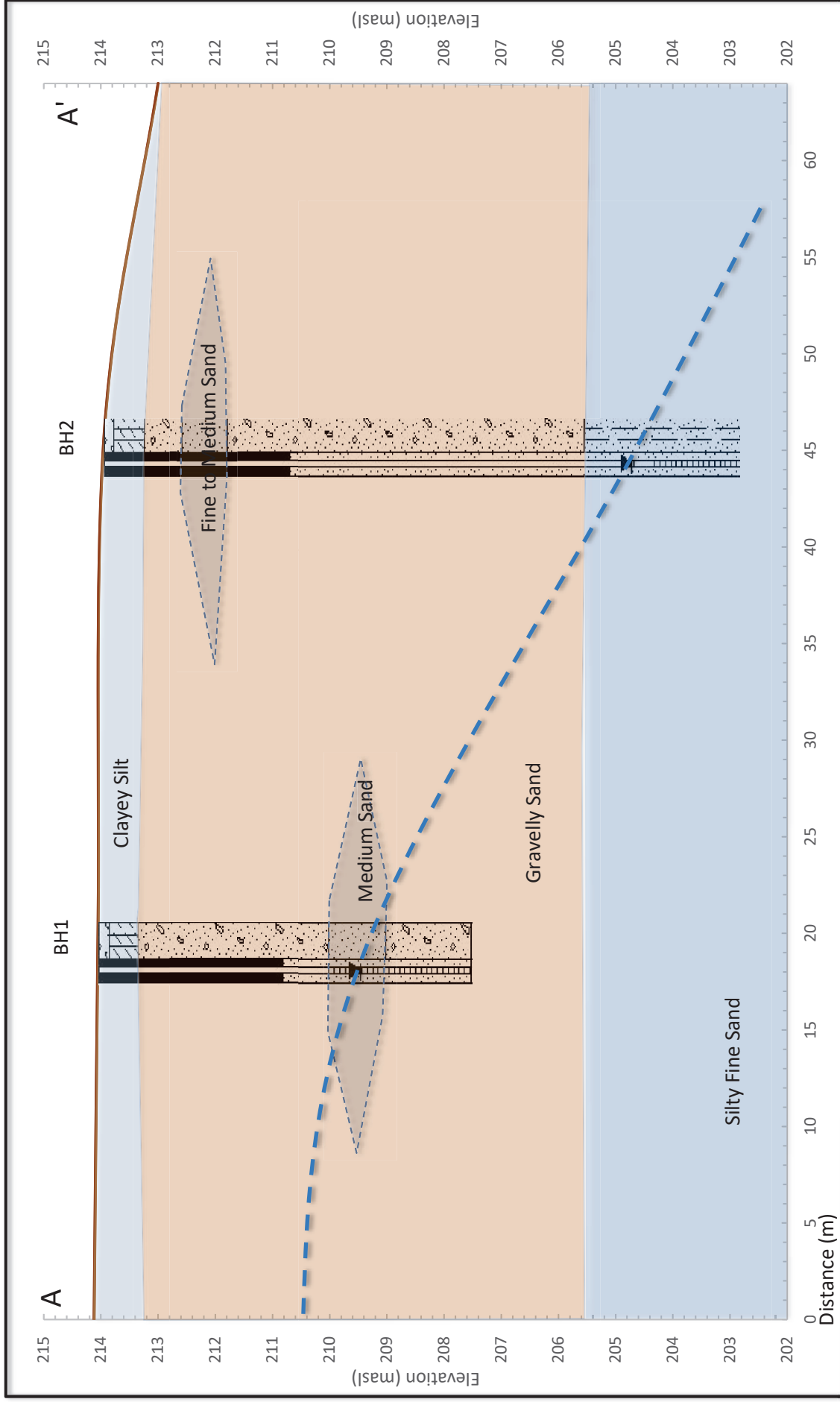

Figure 4: Cross Section A-A'
 (DES21-03-13A May 2021)
 Hydrogeological Assessment
 16621 Hwy 12, Midland, ON

Frontop Engineering Limited
 101 Amber Street, Markham
 ON, L3R 3B2

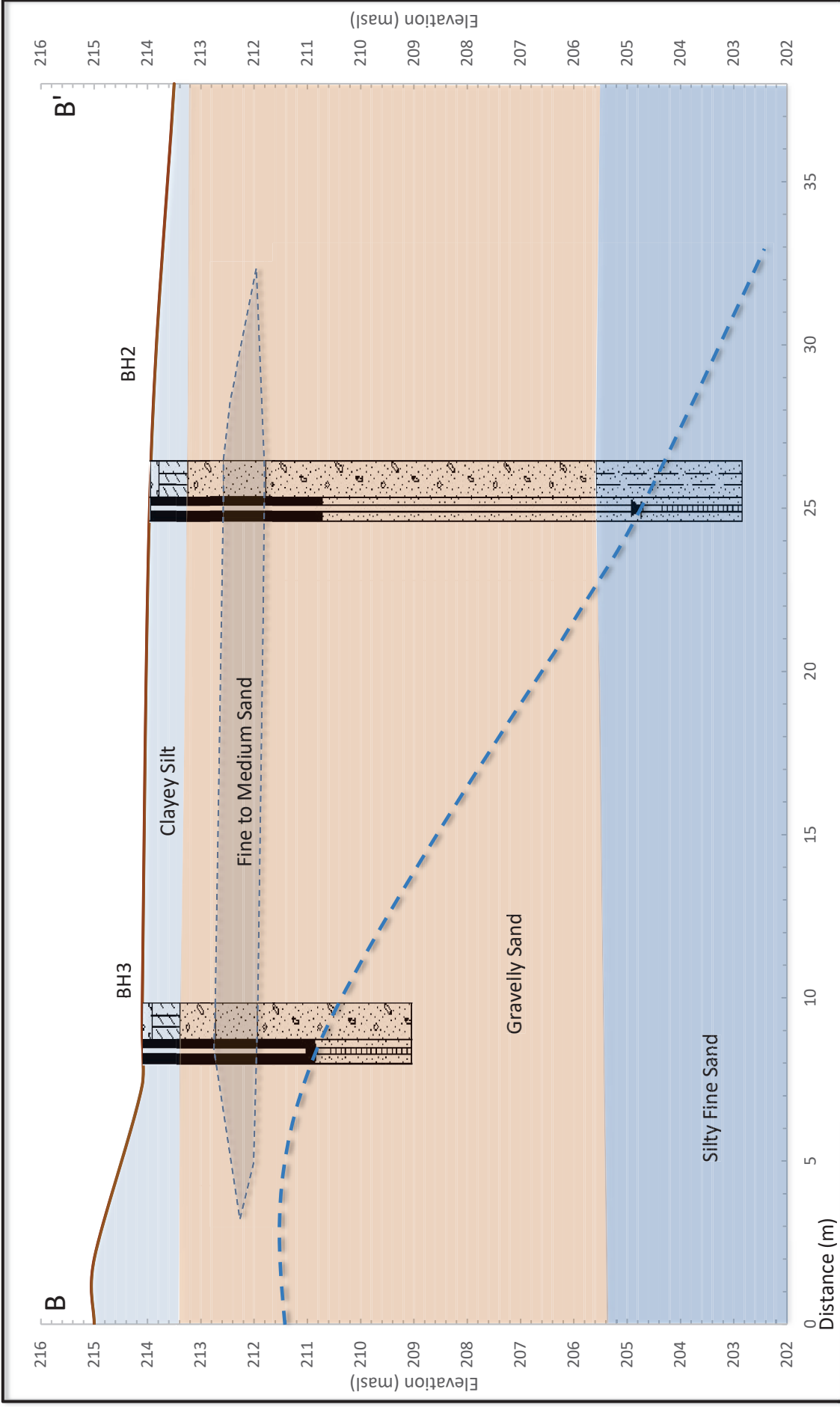

Figure 5: Cross Section B-B'
 (DES21-03-13A May 2021)
 Hydrogeological Assessment
 16621 Hwy 12, Midland, ON









Frontop Engineering Limited
 101 Amber Street, Markham
 ON, L3R 3B2



Figure 5 – Groundwater Table Contours and Flow Direction

Legend

-  Site Boundary
-  Monitoring Well
-  Borehole
-  Section Line
-  Groundwater Contours
-  Groundwater Flow Direction

BH1/209.2
Well ID/Water Level Elvt
210.00: Groundwater Elvt

Figure 5 Groundwater Table
Contour and Flow Direction
DES21-03-13A
May 2021
Hydrogeological Assessment
16621 Hwy 12, Midland, ON

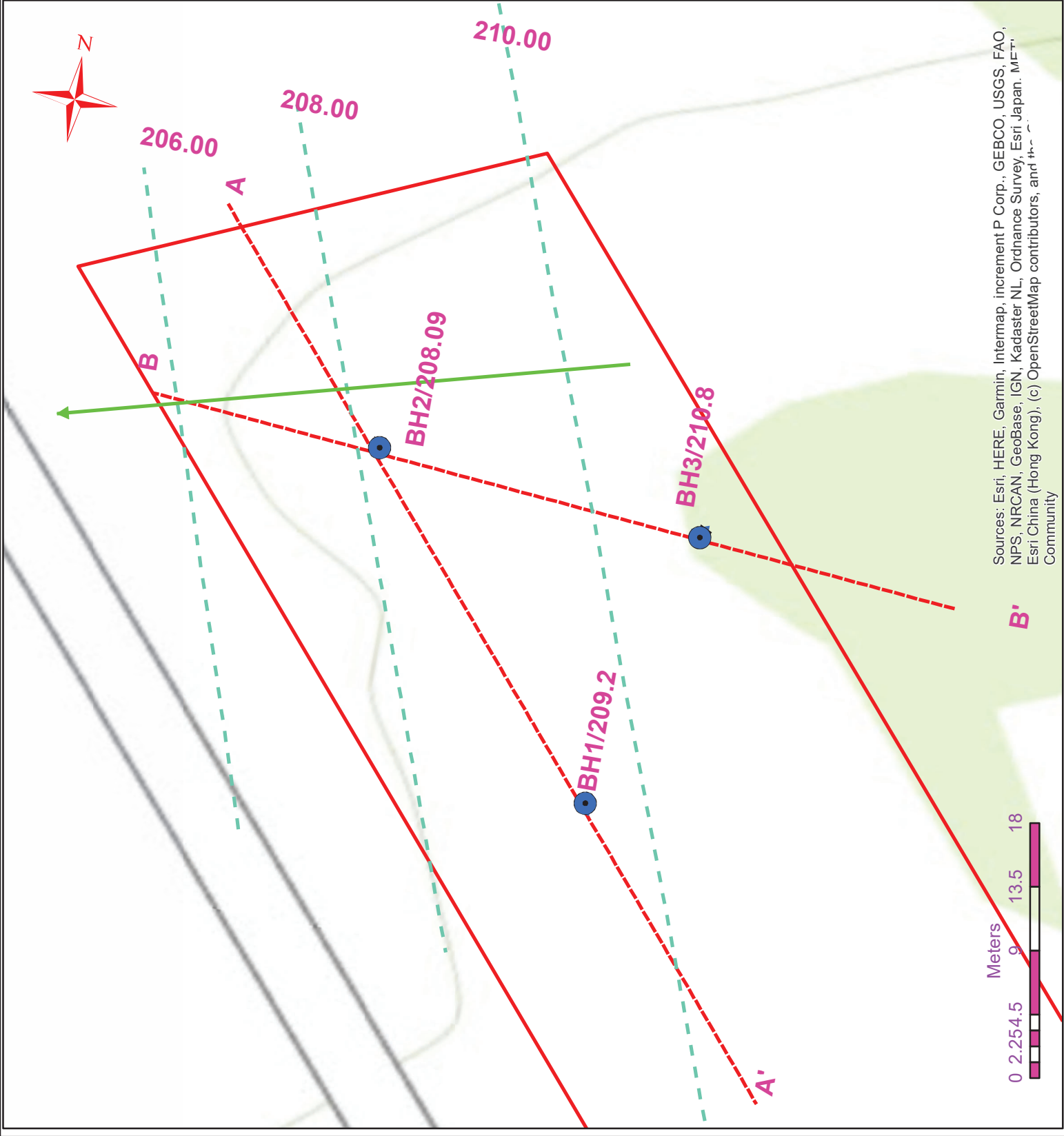

Sources: Esri, HERE, Garmin, Intermap, increment P Corp., GEBCO, USGS, FAO, NPS, NRCAN, GeoBase, IGN, Kadaster NL, Ordnance Survey, Esri Japan, MFT, Esri China (Hong Kong), (c) OpenStreetMap contributors, and the OpenStreetMap Community



Appendix A: Well Records

Well records within 500 m radius of the Site (16621 Hwy 12, Midland, ON)

No	Well ID	Completion Date	Well Depth (m)	Stabilized Water Level (mbgs)	First Found Water Level (mbgs)	Water Quality	Well Use	Well Type
1	5705597	1968-08-13 0:00:00	31.70	25.90			Domestic	Overburden
2	5703891	1965-08-11 0:00:00	37.80	29.00			Domestic	Overburden
3	5703889	1961-11-28 0:00:00	37.50	25.30			Domestic	Overburden
4	7328762	2018-04-04 0:00:00	0.00	0.00				
5	5703888	1957-10-04 0:00:00	44.50	36.90			Domestic	Overburden
6	7318620	2018-07-11 0:00:00	0.00	0.00				
7	5712988	1975-03-02 0:00:00	37.50	24.40			Domestic	Overburden
8	7313561	2018-05-31 0:00:00	0.00	0.00				
9	5703892	1966-05-27 0:00:00	34.10	26.80			Domestic	Overburden
10	5707895	1971-02-10 0:00:00	75.00	0.00				Bedrock
11	4905226	1977-10-13 0:00:00	11.00	6.70			Livestock	Overburden
12	5703908	1963-04-18 0:00:00	34.10	26.50			Livestock	Overburden
13	7183104	2012-04-14 0:00:00	27.40	0.00				
14	7306650	2018-01-09 0:00:00	25.90	0.00			Test Hole	
15	5709260	1972-09-01 0:00:00	51.80	33.50			Commerical	Overburden
16	5703909	1951-10-15 0:00:00	39.90	25.90			Domestic	Overburden
17	5715451	1978-07-20 0:00:00	42.10	28.40			Domestic	Overburden
18	5708920	1972-06-29 0:00:00	32.90	27.10			Domestic	Overburden
19	5707913	1971-03-15 0:00:00	52.40	18.60			Not Used	Bedrock
20	7309627	2018-03-02 0:00:00	8.20	0.00			Test Hole	
21	5703910	1959-07-29 0:00:00	34.80	24.40			Domestic	Overburden
22	5703911	1964-05-06 0:00:00	64.90	0.00			Not Used	Overburden



Appendix B: Slug Test Results



Slug Test (Hvorslev-Falling Head)

(ASTM D4104/D5912 Standard Test Method (Analytical Procedure) for Determining Transmissivity of Nonleaky Confined/Unconfined Aquifers by Overdamped Well Response to Instantaneous Change in Head-Slug Tests)

Project ID: DES21-03-13A

Location: 16621 Hwy 12, Midland, ON

Well ID: BH1

Initial Head (H_0):

Screen Depth (mbgs): 5 - 6.5

Water Head at time t (h): Logger Readings

Well Elevation (masl): 214.05

L = 152 cm

Well Diameter (cm): 4

R = 5 cm

Static Water Level (mbtr): 4.63

r = 2 cm

Finish Reading- h_0 (m): 10.7942 m

$T_0 = 44$ sec

Start Reading- H_0 (m): 11.1853 m

$K = r^2 \ln(L/R) / (2LT_0) = 1.0E-03$ cm/s

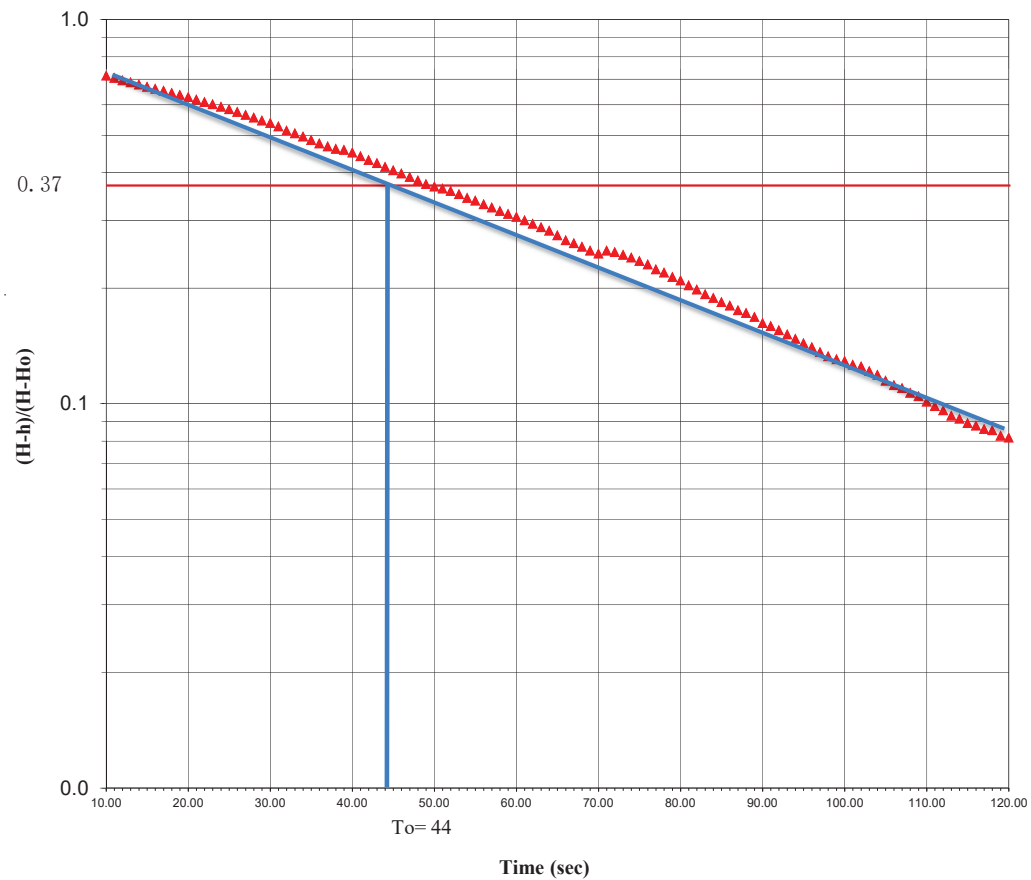

Conducted by: DW

Interpreted by: CL

Date: May 2021



Slug Test (Hvorslev-Falling Head)

(ASTM D4104/D5912 Standard Test Method (Analytical Procedure) for Determining Transmissivity of Nonleaky Confined/Unconfined Aquifers by Overdamped Well Response to Instantaneous Change in Head-Slug Tests)

Project ID: DES21-03-13A

Location: 16621 Hwy 12, Midland, ON

Well ID: BH2
Screen Depth (mbgs): 9.5 - 11
Well Elevation (masl): 213.94
Well Diameter (cm): 4
Static Water Level (mbtr): 9.27
Finish Reading- h_0 (m): 10.7835 m
Start Reading- H_0 (m): 11.1853 m

Initial Head (H_0):

Water Head at time t (h): Logger Readings

L = 152 cm
R = 5 cm
r = 2 cm
To = 59 sec

$$K = r^2 \ln(L/R) / (2LT_0) = 7.6E-04 \text{ cm/s}$$

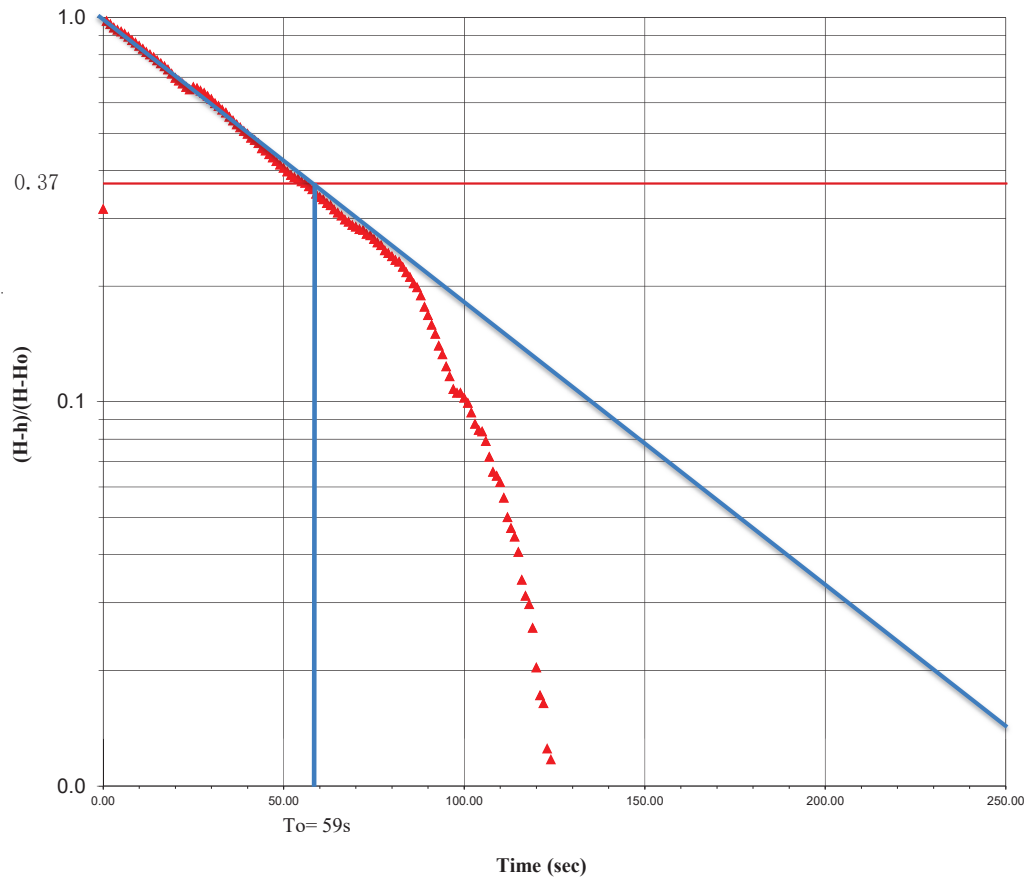

Conducted by: DW

Interpreted by: CL

Date: May 2021



Appendix C: Grain Size Analysis and K-value



Hydraulic Conductivity Report

Sample ID: BH2-1

Date: May 2021

Sample Mass (g): 322

T (oC): 10

Moderately well sorted clay with fines

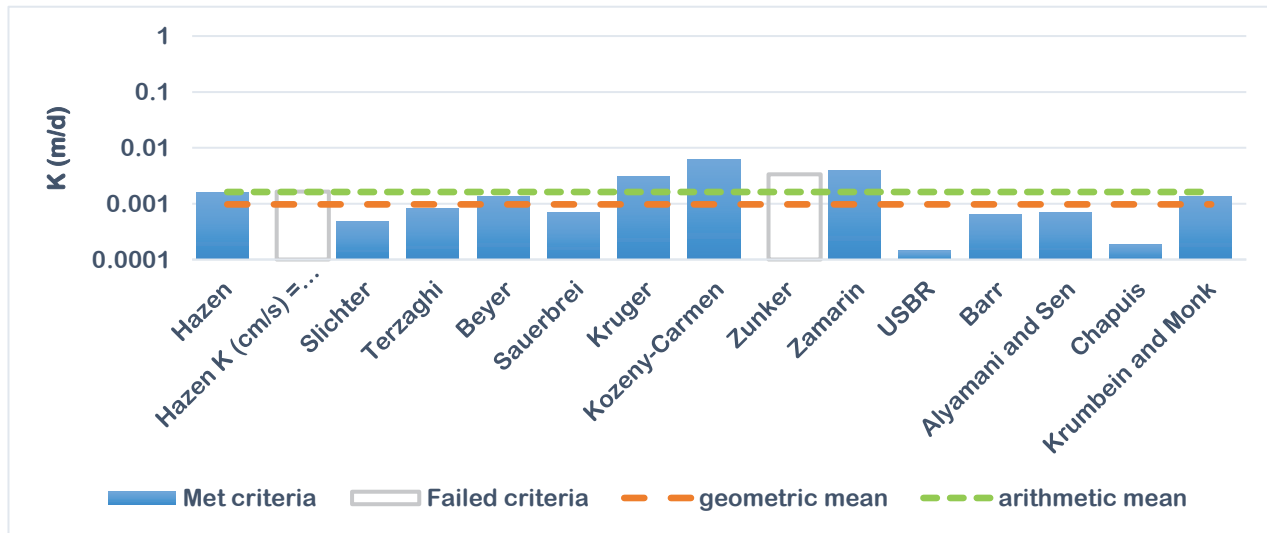

Estimation of Hydraulic Conductivity	cm/s	m/s	m/d
Hazen	.182E-05	.182E-07	0.00
Hazen K (cm/s) = d ₁₀ (mm)	.189E-05	.189E-07	0.00
Slichter	.556E-06	.556E-08	0.00
Terzaghi	.963E-06	.963E-08	0.00
Beyer	.154E-05	.154E-07	0.00
Sauerbrei	.809E-06	.809E-08	0.00
Kruger	.355E-05	.355E-07	0.00
Kozeny-Carmen	.705E-05	.705E-07	0.01
Zunker	.388E-05	.388E-07	0.00
Zamarin	.457E-05	.457E-07	0.00
USBR	.165E-06	.165E-08	0.00
Barr	.755E-06	.755E-08	0.00
Alyamani and Sen	.800E-06	.800E-08	0.00
Chapuis	.212E-06	.212E-08	0.00
Krumbein and Monk	.154E-05	.154E-07	0.00
geometric mean	.112E-05	.112E-07	0.00
arithmetic mean	.187E-05	.187E-07	0.00



Hydraulic Conductivity Report

Sample ID: BH2-6

Date: May 2021

Sample Mass (g): 583

T (oC): 10

Poorly sorted gravelly sand with fines

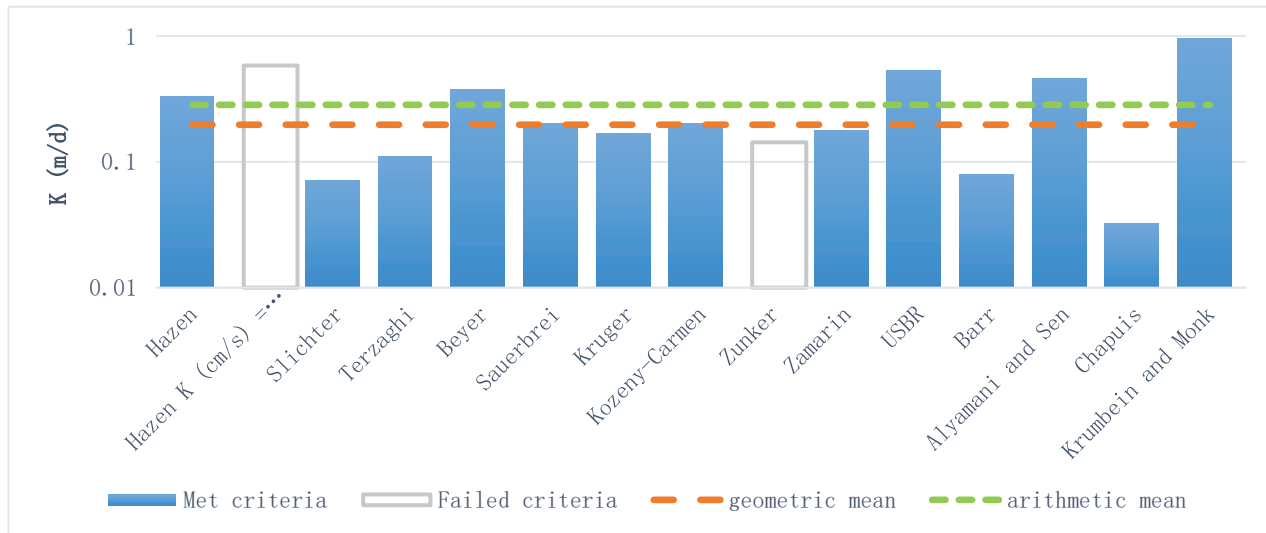

Estimation of Hydraulic Conductivity	cm/s	m/s	m/d
Hazen	.381E-03	.381E-05	0.33
Hazen K (cm/s) = d ₁₀ (mm)	.675E-03	.675E-05	0.58
Slichter	.819E-04	.819E-06	0.07
Terzaghi	.128E-03	.128E-05	0.11
Beyer	.433E-03	.433E-05	0.37
Sauerbrei	.231E-03	.231E-05	0.20
Kruger	.193E-03	.193E-05	0.17
Kozeny-Carmen	.233E-03	.233E-05	0.20
Zunker	.166E-03	.166E-05	0.14
Zamarin	.207E-03	.207E-05	0.18
USBR	.613E-03	.613E-05	0.53
Barr	.923E-04	.923E-06	0.08
Alyamani and Sen	.529E-03	.529E-05	0.46
Chapuis	.372E-04	.372E-06	0.03
Krumbein and Monk	.111E-02	.111E-04	0.96
geometric mean	.228E-03	.228E-05	0.20
arithmetic mean	.329E-03	.329E-05	0.28



Appendix D: Water Quality Test Results



FRONTOP ENGINEERING LIMITED
ATTN: Cheng Yu
101 Amber Street
Units 1 & 2
Markham ON L3R 3B2

Date Received: 20-MAY-21
Report Date: 28-MAY-21 10:57 (MT)
Version: FINAL

Client Phone: 905-947-0900

Certificate of Analysis

Lab Work Order #: L2590198
Project P.O. #: NOT SUBMITTED
Job Reference: DES21-03-13A
C of C Numbers: 20-891518
Legal Site Desc:

Rick Hawthorne
Account Manager

[This report shall not be reproduced except in full without the written authority of the Laboratory.]

ADDRESS: 60 Northland Road, Unit 1, Waterloo, ON N2V 2B8 Canada | Phone: +1 519 886 6910 | Fax: +1 519 886 9047
ALS CANADA LTD Part of the ALS Group An ALS Limited Company

ALS ENVIRONMENTAL ANALYTICAL REPORT

Sample Details/Parameters	Result	Qualifier*	D.L.	Units	Extracted	Analyzed	Batch
L2590198-1 BH3 Sampled By: CLIENT on 19-MAY-21 @ 12:45 Matrix: WATER							
Physical Tests							
pH	7.74		0.10	pH units		22-MAY-21	R5465456
Total Suspended Solids	156000	DLHC	110	mg/L	25-MAY-21	25-MAY-21	R5466988
Bacteriological Tests							
Fecal Coliforms	<10	DLM	10	CFU/100mL		20-MAY-21	R5462479
Total Metals							
Cadmium (Cd)-Total	0.000434	DLHC	0.000050	mg/L	21-MAY-21	21-MAY-21	R5462060
Chromium (Cr)-Total	0.343	DLHC	0.0050	mg/L	21-MAY-21	21-MAY-21	R5462060
Copper (Cu)-Total	0.195	DLHC	0.0050	mg/L	21-MAY-21	21-MAY-21	R5462060
Lead (Pb)-Total	0.0544	DLHC	0.00050	mg/L	21-MAY-21	21-MAY-21	R5462060
Mercury (Hg)-Total	0.0000053		0.0000050	mg/L		21-MAY-21	R5462057
Nickel (Ni)-Total	0.136	DLHC	0.0050	mg/L	21-MAY-21	21-MAY-21	R5462060
Zinc (Zn)-Total	0.306	DLHC	0.030	mg/L	21-MAY-21	21-MAY-21	R5462060
Aggregate Organics							
Oil and Grease, Total	<5.0		5.0	mg/L	27-MAY-21	27-MAY-21	R5473887
Animal/Veg Oil & Grease	<5.0		5.0	mg/L		28-MAY-21	
Mineral Oil and Grease	<2.5		2.5	mg/L	27-MAY-21	27-MAY-21	R5473887

* Refer to Referenced Information for Qualifiers (if any) and Methodology.

Reference Information

Sample Parameter Qualifier key listed:

Qualifier	Description
DLHC	Detection Limit Raised: Dilution required due to high concentration of test analyte(s).
DLM	Detection Limit Adjusted due to sample matrix effects (e.g. chemical interference, colour, turbidity).

Test Method References:

ALS Test Code	Matrix	Test Description	Method Reference**
EC-SCREEN-WT	Water	Conductivity Screen (Internal Use Only)	APHA 2510

Qualitative analysis of conductivity where required during preparation of other tests - e.g. TDS, metals, etc.

FC-WW-MF-WT	Water	Fecal Coliforms	APHA 9223B
FC-WW-MF-WT	Water	Fecal Coliforms	SM 9222D
HG-T-CVAA-WT	Water	Total Mercury in Water by CVAAS	EPA 1631E (mod)

Water samples undergo a cold-oxidation using bromine monochloride prior to reduction with stannous chloride, and analyzed by CVAAS.

MET-T-CCMS-WT	Water	Total Metals in Water by CRC ICPMS	EPA 200.2/6020A (mod)
---------------	-------	------------------------------------	-----------------------

Water samples are digested with nitric and hydrochloric acids, and analyzed by CRC ICPMS.

Method Limitation (re: Sulfur): Sulfide and volatile sulfur species may not be recovered by this method.

Analysis conducted in accordance with the Protocol for Analytical Methods Used in the Assessment of Properties under Part XV.1 of the Environmental Protection Act (July 1, 2011).

OGG-SPEC-CALC-WT	Water	Speciated Oil and Grease A/V Calc	CALCULATION
------------------	-------	-----------------------------------	-------------

Sample is extracted with hexane, sample speciation into mineral and animal/vegetable fractions is achieved via silica gel separation and is then determined gravimetrically.

OGG-SPEC-WT	Water	Speciated Oil and Grease-Gravimetric	APHA 5520 B
-------------	-------	--------------------------------------	-------------

The procedure involves an extraction of the entire water sample with hexane. Sample speciation into mineral and animal/vegetable fractions is achieved via silica gel separation and is then determined gravimetrically.

PH-WT	Water	pH	APHA 4500 H-Electrode
-------	-------	----	-----------------------

Water samples are analyzed directly by a calibrated pH meter.

Analysis conducted in accordance with the Protocol for Analytical Methods Used in the Assessment of Properties under Part XV.1 of the Environmental Protection Act (July 1, 2011). Holdtime for samples under this regulation is 28 days

SOLIDS-TSS-WT	Water	Suspended solids	APHA 2540 D-Gravimetric
---------------	-------	------------------	-------------------------

A well-mixed sample is filtered through a weighed standard glass fibre filter and the residue retained is dried in an oven at 104–110°C for a minimum of four hours or until a constant weight is achieved.

** ALS test methods may incorporate modifications from specified reference methods to improve performance.

The last two letters of the above test code(s) indicate the laboratory that performed analytical analysis for that test. Refer to the list below:

Laboratory Definition Code	Laboratory Location
WT	ALS ENVIRONMENTAL - WATERLOO, ONTARIO, CANADA

Chain of Custody Numbers:

20-891518

Reference Information

GLOSSARY OF REPORT TERMS

Surrogates are compounds that are similar in behaviour to target analyte(s), but that do not normally occur in environmental samples. For applicable tests, surrogates are added to samples prior to analysis as a check on recovery. In reports that display the D.L. column, laboratory objectives for surrogates are listed there.

mg/kg - milligrams per kilogram based on dry weight of sample

mg/kg wwt - milligrams per kilogram based on wet weight of sample

mg/kg lwt - milligrams per kilogram based on lipid weight of sample

mg/L - unit of concentration based on volume, parts per million.

< - Less than.

D.L. - The reporting limit.

N/A - Result not available. Refer to qualifier code and definition for explanation.

Test results reported relate only to the samples as received by the laboratory.

UNLESS OTHERWISE STATED, ALL SAMPLES WERE RECEIVED IN ACCEPTABLE CONDITION.

Analytical results in unsigned test reports with the DRAFT watermark are subject to change, pending final QC review.



Quality Control Report

Workorder: L2590198

Report Date: 28-MAY-21

Page 1 of 3

Client: FRONTOP ENGINEERING LIMITED
 101 Amber Street Units 1 & 2
 Markham ON L3R 3B2

Contact: Cheng Yu

Test	Matrix	Reference	Result	Qualifier	Units	RPD	Limit	Analyzed
FC-WW-MF-WT								
	Water							
Batch	R5462479							
WG3538677-3	DUP	L2590198-1						
Fecal Coliforms		<10	<10	RPD-NA	CFU/100mL	N/A	50	20-MAY-21
WG3538677-1	MB							
Fecal Coliforms			0		CFU/100mL		1	20-MAY-21
HG-T-CVAA-WT								
	Water							
Batch	R5462057							
WG3539182-2	LCS							
Mercury (Hg)-Total			101.0		%		80-120	21-MAY-21
WG3539182-1	MB							
Mercury (Hg)-Total			<0.000005C		mg/L		0.000005	21-MAY-21
MET-T-CCMS-WT								
	Water							
Batch	R5462060							
WG3539047-2	LCS							
Cadmium (Cd)-Total			102.1		%		80-120	21-MAY-21
Chromium (Cr)-Total			99.9		%		80-120	21-MAY-21
Copper (Cu)-Total			97.4		%		80-120	21-MAY-21
Lead (Pb)-Total			102.9		%		80-120	21-MAY-21
Nickel (Ni)-Total			99.0		%		80-120	21-MAY-21
Zinc (Zn)-Total			99.3		%		80-120	21-MAY-21
WG3539047-1	MB							
Cadmium (Cd)-Total			<0.000005C		mg/L		0.000005	21-MAY-21
Chromium (Cr)-Total			<0.00050		mg/L		0.0005	21-MAY-21
Copper (Cu)-Total			<0.00050		mg/L		0.0005	21-MAY-21
Lead (Pb)-Total			<0.000050		mg/L		0.00005	21-MAY-21
Nickel (Ni)-Total			<0.00050		mg/L		0.0005	21-MAY-21
Zinc (Zn)-Total			<0.0030		mg/L		0.003	21-MAY-21
OGG-SPEC-WT								
	Water							
Batch	R5473887							
WG3542063-2	LCS							
Oil and Grease, Total			98.3		%		70-130	27-MAY-21
Mineral Oil and Grease			94.8		%		70-130	27-MAY-21
WG3542063-1	MB							
Oil and Grease, Total			<5.0		mg/L		5	27-MAY-21
Mineral Oil and Grease			<2.5		mg/L		2.5	27-MAY-21
PH-WT	Water							



Quality Control Report

Workorder: L2590198

Report Date: 28-MAY-21

Page 2 of 3

Test	Matrix	Reference	Result	Qualifier	Units	RPD	Limit	Analyzed
PH-WT	Water							
Batch	R5465456							
WG3539933-2	LCS							
pH			7.00		pH units		6.9-7.1	22-MAY-21
SOLIDS-TSS-WT	Water							
Batch	R5466988							
WG3540429-2	LCS							
Total Suspended Solids			98.0		%		85-115	25-MAY-21
WG3540429-1	MB							
Total Suspended Solids			<3.0		mg/L		3	25-MAY-21

Quality Control Report

Workorder: L2590198

Report Date: 28-MAY-21

Page 3 of 3

Legend:

Limit	ALS Control Limit (Data Quality Objectives)
DUP	Duplicate
RPD	Relative Percent Difference
N/A	Not Available
LCS	Laboratory Control Sample
SRM	Standard Reference Material
MS	Matrix Spike
MSD	Matrix Spike Duplicate
ADE	Average Desorption Efficiency
MB	Method Blank
IRM	Internal Reference Material
CRM	Certified Reference Material
CCV	Continuing Calibration Verification
CVS	Calibration Verification Standard
LCSD	Laboratory Control Sample Duplicate

Sample Parameter Qualifier Definitions:

Qualifier	Description
RPD-NA	Relative Percent Difference Not Available due to result(s) being less than detection limit.

Hold Time Exceedances:

All test results reported with this submission were conducted within ALS recommended hold times.

ALS recommended hold times may vary by province. They are assigned to meet known provincial and/or federal government requirements. In the absence of regulatory hold times, ALS establishes recommendations based on guidelines published by the US EPA, APHA Standard Methods, or Environment Canada (where available). For more information, please contact ALS.

The ALS Quality Control Report is provided to ALS clients upon request. ALS includes comprehensive QC checks with every analysis to ensure our high standards of quality are met. Each QC result has a known or expected target value, which is compared against pre-determined data quality objectives to provide confidence in the accuracy of associated test results.

Please note that this report may contain QC results from anonymous Sample Duplicates and Matrix Spikes that do not originate from this Work Order.

Chain of Custody (COC) / Analytical Request Form

COC Number: 20-891518

Page of

Canada Toll Free: 1 800 668 9878

www.alsglobal.com



Report To Contact and company name below will appear on the final report Company: <u>Frontop Engineering</u> Contact: <u>Cheng Yu Liu</u> Phone: <u>905-947-8900 ext 319</u> Company address below will appear on the final report Street: <u>101 Amber St</u> City/Province: <u>Markham, ON</u> Postal Code: <u>L3R 3B2</u>		Reports / Recipients Select Report Format: <input checked="" type="checkbox"/> EXCEL <input type="checkbox"/> EDO (DIGITAL) Merge QC/QCI Reports with COA <input type="checkbox"/> YES <input type="checkbox"/> NO <input type="checkbox"/> N/A <input type="checkbox"/> Compare Results to Criteria on Report - provide details below if box checked Select Distribution: <input checked="" type="checkbox"/> EMAIL <input type="checkbox"/> MAIL <input type="checkbox"/> FAX Email 1 or Fax: <u>chengyu@frontop.ca</u> Email 2 Email 3		Turnaround Time (TAT) Requested <input type="checkbox"/> Routine (R) if received by 3pm M-F - no surcharges apply <input type="checkbox"/> 4 day (P4) if received by 3pm M-F - 20% rush surcharge minimum <input type="checkbox"/> 3 day (P3) if received by 3pm M-F - 25% rush surcharge minimum <input type="checkbox"/> 2 day (P2) if received by 3pm M-F - 50% rush surcharge minimum <input type="checkbox"/> 1 day (E) if received by 3pm M-F - 100% rush surcharge minimum Same day (E2) if received by 10am M-S - 200% rush surcharge. Additional fees may apply to rush requests on weekends, statutory holidays and non-routine tests	
Invoice To Same as Report To <input checked="" type="checkbox"/> YES <input type="checkbox"/> NO Copy of Invoice with Report <input checked="" type="checkbox"/> YES <input type="checkbox"/> NO		Invoice Recipients Select Invoice Distribution: <input checked="" type="checkbox"/> EMAIL <input type="checkbox"/> MAIL <input type="checkbox"/> FAX Email 1 or Fax: <u>chengyu@frontop.ca</u> Email 2 Email 3		Date and Time Required for all ESP TATs: For all tests with rush TATs requested, please contact your AM to confirm availability.	
Company: Contact:		Oil and Gas Required Fields (client use) AFE/Cost Center: PO# Major/Minor Code: Routing Code: Requisitioner: Location:		Analysis Request Indicate Filtered (F), Preserved (P) or Filtered and Preserved (FP) below	
ALS Account # / Quote #: Job #: <u>D3521-03-13A</u> PO / AFE: LSD:		ALS Contact: ALS Lab Work Order* (ALS use only): <u>L2590198</u> Sample Identification and/or Coordinates (This description will appear on the report): <u>BH3</u>		SUSPECTED HAZARD (see notes) EXTENDED STORAGE REQUIRED SAMPLES ON HOLD	
Drinking Water (DW) Samples (client use) Are samples taken from a Regulated DW System? <input type="checkbox"/> YES <input checked="" type="checkbox"/> NO Are samples for human consumption/ use? <input type="checkbox"/> YES <input checked="" type="checkbox"/> NO		Notes / Specify Limits for result evaluation by selecting from drop-down below (Excel COC only)		NUMBER OF CONTAINERS <u>6</u> (Midland storm sewer)	
SHIPMENT RELEASE (client use) Released by: <u>Chengyu Liu</u> Date: <u>May 19, 21</u>		INITIAL SHIPMENT RECEPTION (ALS use only) Received by: <u>[Signature]</u> Date: <u>May 20/21</u> Time: <u>9:00</u>		SAMPLE RECEIPT DETAILS (ALS use only) Cooling Method: <input type="checkbox"/> NONE <input type="checkbox"/> ICE <input checked="" type="checkbox"/> PACKS <input type="checkbox"/> FROZEN <input type="checkbox"/> COOLING INITIATED Submission Comments identified on Sample Receipt Notification: <input type="checkbox"/> YES <input type="checkbox"/> NO Cooler Custody Seals Intact: <input type="checkbox"/> YES <input type="checkbox"/> N/A <input type="checkbox"/> Sample Custody Seals Intact: <input type="checkbox"/> YES <input type="checkbox"/> N/A INITIAL COOLER TEMPERATURES °C: <u>13.3</u> FINAL COOLER TEMPERATURES °C: <u>8.4</u>	
FINAL SHIPMENT RECEPTION (ALS use only) Received by: <u>[Signature]</u> Date: <u>May 20/21</u> Time: <u>9:00</u>		FINAL SHIPMENT RECEPTION (ALS use only) Received by: <u>[Signature]</u> Date: <u>May 20/21</u> Time: <u>9:00</u>		Final Shipment Receipt (ALS use only)	



Failure to complete all portions of this form may delay analysis. Please fill in this form LEGIBLY. By the use of this form the user acknowledges and agrees with the Terms and Conditions as specified on the back page of the white - report copy.
 1. If any water samples are taken from a Regulated Drinking Water (DW) System, please submit using an Authorized DW COC form.



Appendix E: Gas Tank Specification

ZCL
COMPOSITES INC.



PREZERVER™

Fiberglass Double Wall Underground Storage Tank Systems



The Double Wall Storage Tank System of Choice...

Your best response to secondary containment regulations...

If legislation requires you to install secondary containment, ZCL Prezerver™ double wall tanks make compliance easy and economical.

100% premium grade resin and double wall reinforced plastic provides long lasting corrosion free internal and external service.

No more leaks or spills due to corrosion,

ZCL tanks simply will not rust!

Prezerver™ tanks can be installed individually or coupled with a completely integrated underground user friendly storage and handling system including double wall flexible piping, engineered pre-cast concrete anchors and fiberglass straps, containment and dispenser sumps, and a leak detection system.

Installation costs are reduced – **No Heavy cranes are necessary** thanks to Prezerver's lightweight construction.

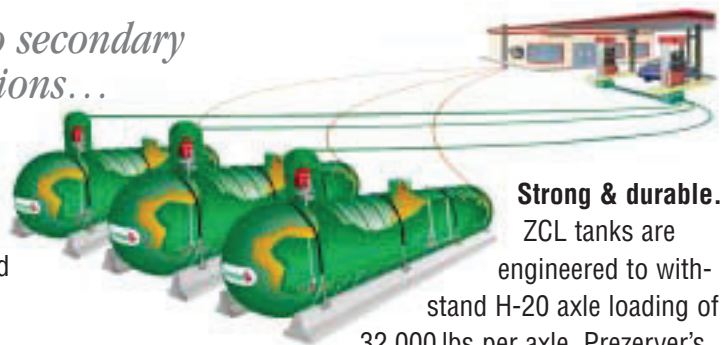

Strong & durable...

ZCL tanks are engineered to withstand H-20 axle loading of

32,000 lbs per axle. Prezerver's

integral rib/tank interface (no rib delamination) allows burial to a depth of seven feet in wet or dry soil conditions. Tanks range in size (2500–100,000 litres) and formats, **including cost effective multi compartments** which allow you to store 2 or more products in the same tank.

A true long term asset, Prezerver™ tanks **can be moved and reused, even after many years** of trouble-free service.

Your quality assurance...

All Prezerver™ tanks are manufactured to applicable ULC requirements and are backed by a comprehensive warranty.

The only tank that guarantees long term 'peace of mind' with a 30 YEAR Comprehensive Warranty

Five important factors to consider before buying a tank...

1 Does it offer true secondary containment?

Prezerver™ double-wall tanks give you two levels of protection, so you have twice the assurance and risk management of any single-wall tank. The primary tank is designed to contain your fuel. In the unlikely event that there is a breach in the inner wall, the secondary wall (a full 360 degree containment) is designed to contain your product and prevent a spill into the environment.

2 Are both walls rust-proof and maintenance-free?

ZCL's Prezerver™ fiberglass double-wall tanks are rust-proof, maintenance free and formulated to be compatible with all petroleum fuel products, alcohols and alcohol-gasoline mixtures.

“PREZERVER™ Tanks are designed for environmentally safe underground storage of petroleum products, alcohol blended fuels and a variety of chemicals.”





Get the permanent solution for safe secondary containment...

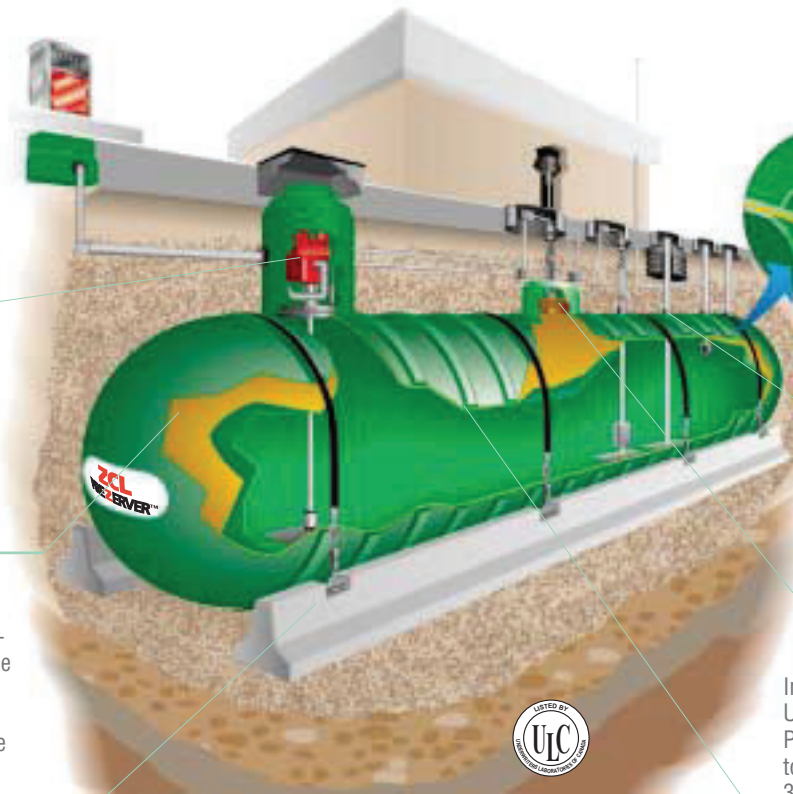

Turbine Enclosure protects submersible pump from corrosive soil. Provides secondary containment of possible leaks from pump or piping.

Double Wall Fiberglass is rust-proof inside and out, 100% resin & glass construction is maintenance free, easy to handle and requires no expensive cathodic protection.

Pre-cast Concrete Tank Anchors – eliminate the need of pour-in-place concrete pad and are designed to prevent uplift at full flood conditions. Hook to hook non-corrosive fiberglass straps with galvanized turnbuckles provide convenience and security.

Annular Space between inner and outer walls provides continuous leak detection of both walls. Interstice cavity can be shipped from the factory brine-filled.

Tank Mounted Fittings – provide access for high/low level electronic inventory gauges and pump out.

Monitor Reservoir allows precision tank testing and leak detection by providing Four low cost Monitoring Options - Pressure, Vacuum, Dry and Hydrostatic.

Integrally Constructed Ribs – Ultra-strong and robust, Prezerver™ tanks are engineered to withstand H-20 axle loading of 32,000lbs per axle. Tanks can be buried to depths of 7ft. and more.



PREZERVER™ *Double Wall Fuel storage Tank*

Designed to deliver
more than twice the service life
of other tanks!

3 Can it be pressure tested on-site?
Unlike other types of double-wall or jacketed tanks, Prezerver's secondary containment can be pressure tested at the installation site both prior to and after installation.

4 Can both walls be monitored for structural integrity?
ZCL's advanced double-wall technology uses an amazing 3D glass fabric that's cured with thermosetting resin to create an interstitial space "sandwich" laminate. Both inner and outer walls are bonded together, providing walls which can be easily monitored for structural integrity.

5 Does it promise long life?
Prezerver™ fiberglass double-wall tanks are ULC-listed for underground storage applications. Fiberglass simply does not corrode which makes Prezerver™ likely the last tank you will ever have to buy.

ZCL PREZERVER™ Tank Specification Sheet

For P40, P60, P86, and P100 Series Double Wall Tanks with ZCL Tank Anchors & Straps

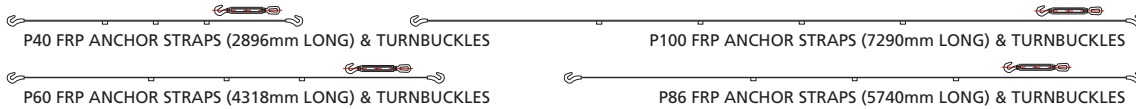
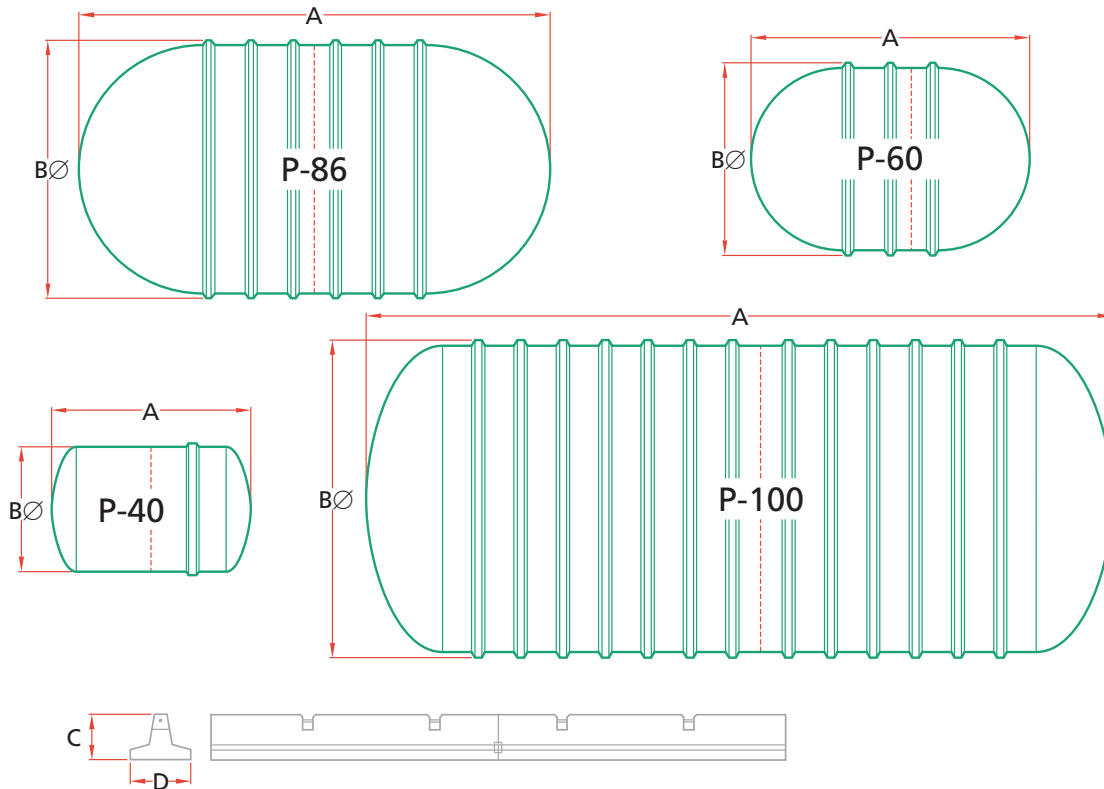

Model Number & Nominal Capacity	Actual Capacity	Dimension (mm)				No. of Anchors	No. of Straps	Nominal Weight (kg)	
		A	B	C	D			Tank	Anchors
P40DW - 2,500 L	2,538 L	2303	1256	305	457	2	2	153	957
P40DW - 5,000 L	5,073 L	4380	1256	305	457	2	2	293	1,763
P60DW - 10,000 L	10,002 L	4525	1930	457	610	2	2	662	3,005
P60DW - 15,000 L	15,339 L	6599	1930	457	610	2	2	867	4,382
P60DW - 20,000 L	20,042 L	8433	1930	457	610	2	4	1,043	5,600
P60DW - 25,000 L	25,135 L	10412	1930	457	610	4	4	1,200	6,914
P86DW - 15,000 L	15,003 L	3980	2590	457	610	2	2	744	2,643
P86DW - 20,000 L	20,523 L	5134	2590	457	610	2	2	918	3,409
P86DW - 25,000 L	25,006 L	6073	2590	457	610	2	2	1,051	4,032
P86DW - 30,000 L	30,689 L	7259	2590	457	610	2	4	1,228	4,820
P86DW - 35,000 L	35,003 L	8160	2590	457	610	2	4	1,357	5,418
P86DW - 40,000 L	40,854 L	9384	2590	457	610	4	4	1,538	6,231
P86DW - 45,000 L	45,541 L	10361	2590	457	610	4	4	1,675	6,880
P86DW - 50,000 L	50,004 L	11300	2590	457	610	4	4	1,807	7,503
P86DW - 60,000 L	60,541 L	13501	2590	457	610	6	6	2,000	8,965
P86DW - 65,000 L	65,407 L	14522	2590	457	610	6	6	2,200	9,643
P100DW - 50,000 L	50,228 L	7449	3188	457	610	4	4	2,699	4,946
P100DW - 60,000 L	60,219 L	8827	3188	457	610	4	6	2,961	5,861
P100DW - 75,000 L	75,288 L	10903	3188	457	610	6	6	3,371	7,240
P100DW - 90,000 L	90,996 L	13068	3188	457	610	6	8	3,896	8,677
P100DW - 100,000 L	100,261 L	14345	3188	457	610	6	8	4,158	9,525

Dimensional Data

4 ft. Tanks – P40DW Series

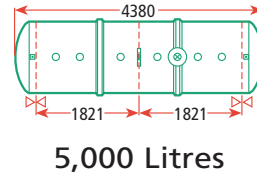
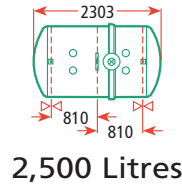

6 ft. Tanks – P60DW Series

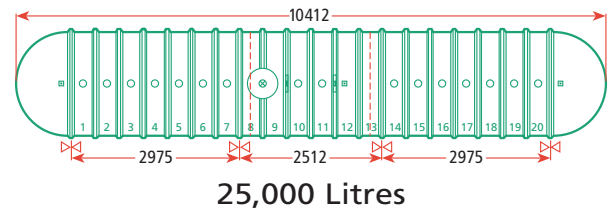
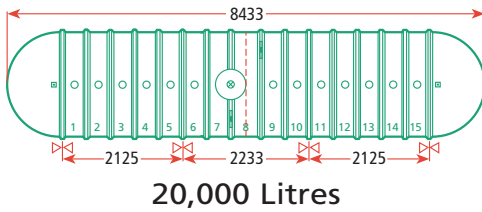
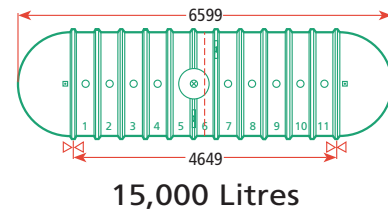
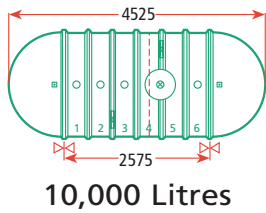

8½ ft. Tanks – P86DW Series

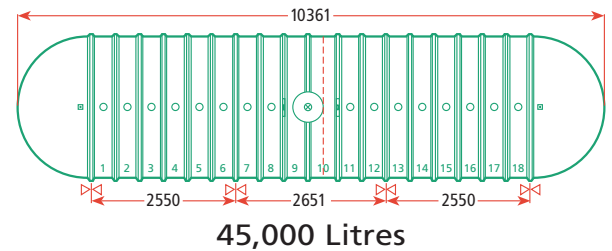
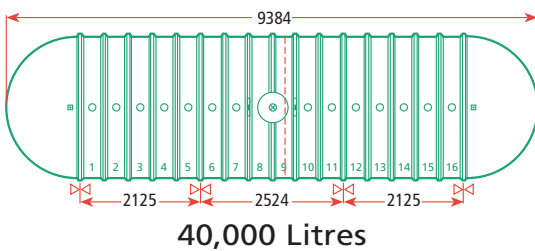
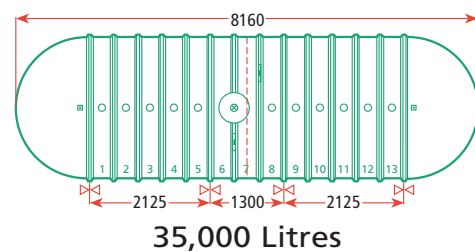
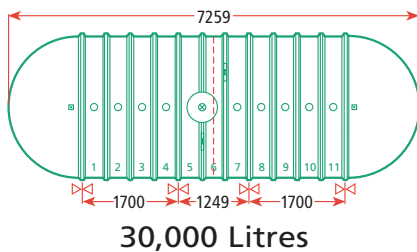
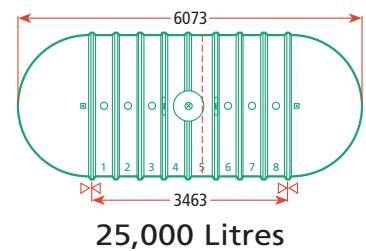
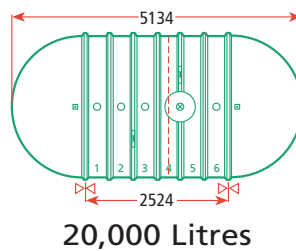
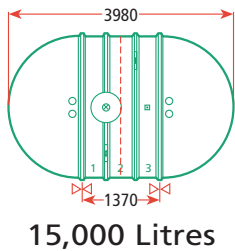

8½ ft. Tanks – P86DW Series (continued)

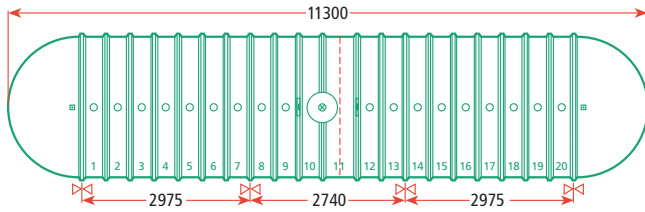

50,000 Litres

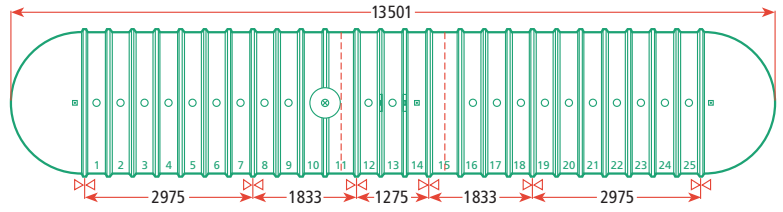

60,000 Litres

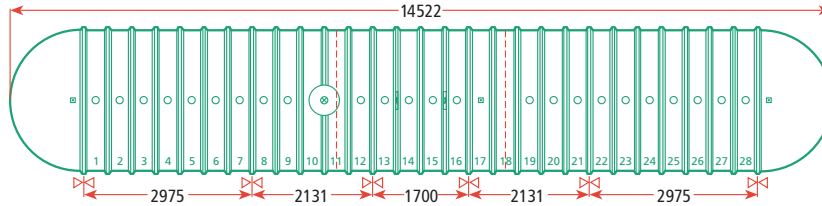

65,000 Litres

10 ft. Tanks – P100DW Series

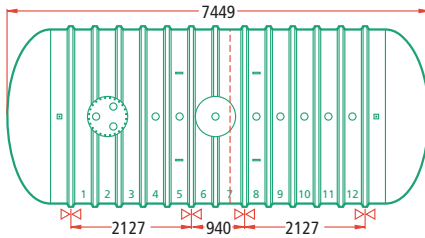

50,000 Litres

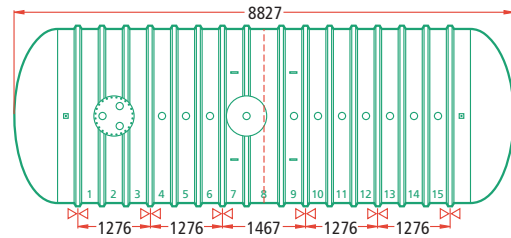

60,000 Litres

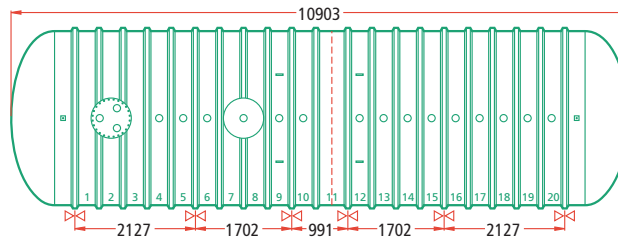

75,000 Litres

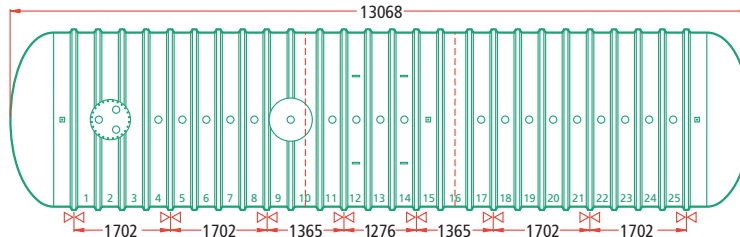

90,000 Litres

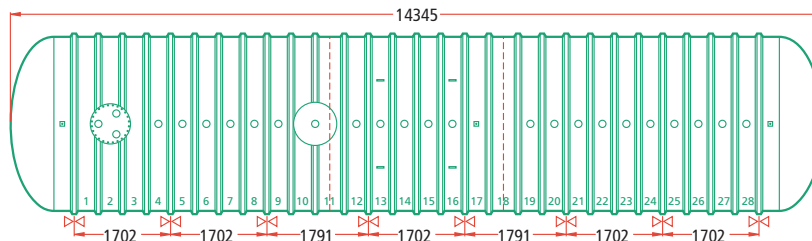

100,000 Litres

6 ft. Tank Extensions – P60DW Series

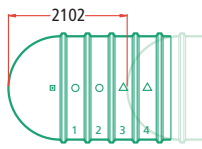

5,000 Litres

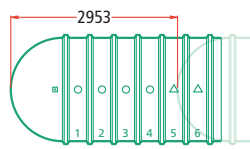

7,500 Litres

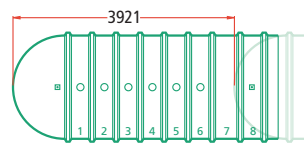

10,000 Litres

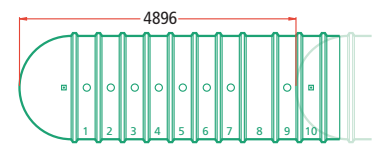

12,500 Litres

8½ ft. Tank Extensions – P86DW Series

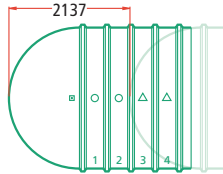

10,000 Litres

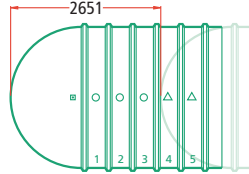

12,500 Litres

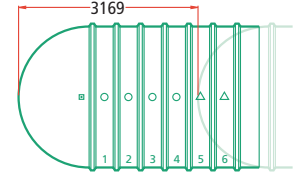

15,000 Litres

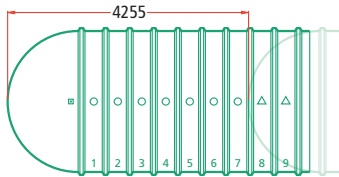

20,000 Litres

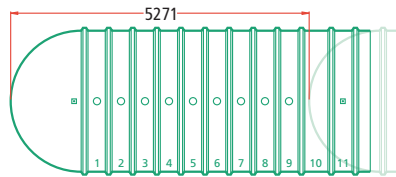

25,000 Litres

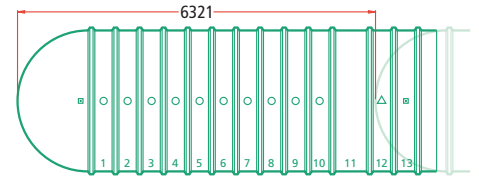

30,000 Litres

10 ft. Tank Extensions – P100DW Series

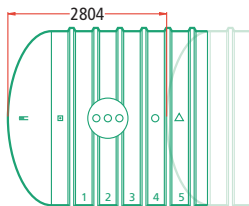

20,000 Litres

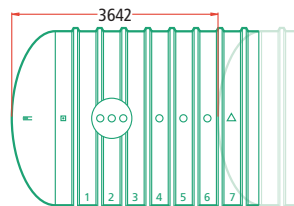

25,000 Litres

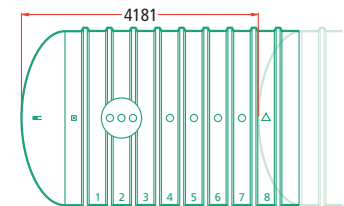

30,000 Litres

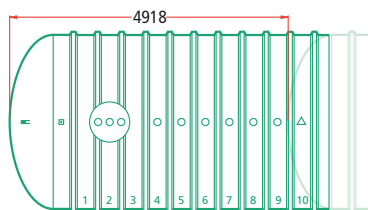

35,000 Litres

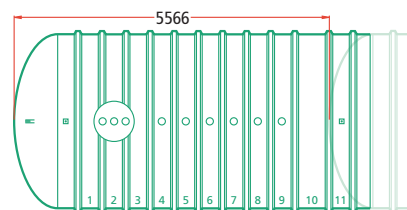

40,000 Litres

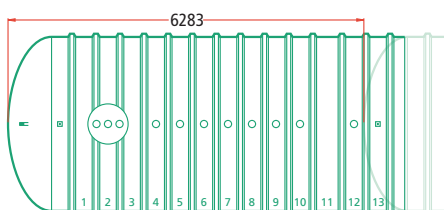

45,000 Litres

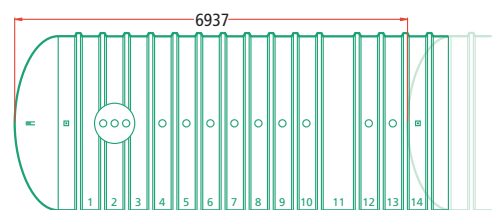

50,000 Litres

Your assurance of quality...

ZCL Composites Inc. is the most trusted name in the petroleum industry for providing environmentally safe products. Our tanks are the benchmark for today's higher standards of environmental protection.

Canada's #1 fiberglass tank manufacturer.



Quality Design – Standard Features

- Unsurpassed Fiberglass Double Wall construction using 100% premium resins and glass that provides corrosion resistant internal and external service.
- Integral Ribs made of the same material as the tank add strength, providing for a structurally sound tank that is “second to none”.
- Fiberglass Prezerver™ Double Wall tanks reduce expenses. Maintenance free, they require no corrosion maintenance or monitoring.
- All Prezerver™ Fiberglass Underground Double Wall tanks will provide long, trouble-free service. Each tank can be removed, and after recertification be re-installed.
- Lightweight Design – Easy to ship, easy to handle and install.
- Interstitial Design using an amazing 3D glass fabric technology allows for four monitoring options of the tank's integrity: pressure, vacuum, dry, or hydrostatic.

Specifications

- Tank holding capacities range from 2500 litres to 100,000 litres in 4', 6', 8'6" and 10' diameters.
- Standard 4" NPT fittings.
- Engineered to withstand H-20 axle loading of 32,000 lbs per axle.
- Burial depth up to seven feet in wet or dry soil condition.
- Available in metric sizes and optional imperial sizes

Quality Controls

- Every Prezerver™ tank is manufactured to applicable requirements of Underwriters' Laboratories of Canada ULC S-615.
- All Prezerver™ Double Wall tanks are subjected to stringent quality control processes that ensure tank tightness-both before and after installation, including positive air pressure test of 5psi and vacuum tested in accordance with ULC requirements.

Warranty

- Prezerver™ tanks are backed by a comprehensive 30 year warranty

Prezerver™ is a registered trademark of ZCL Composites Inc.

For more information, contact

ZCL
COMPOSITES INC.

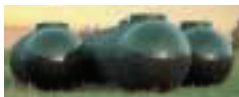

1-800-661-8265
www.zcl.com

